

Heavy Ion Experimental 2

Hard Probes
(focus on jets)

Megan Connors

NNPSS

June 22, 2018



Hard Probes

- Unlike bulk observables: multiplicity, flow...
- Hard probes penetrate the medium
 - Heavy flavor quarks & high momentum partons
 - Modifications reveal interaction:

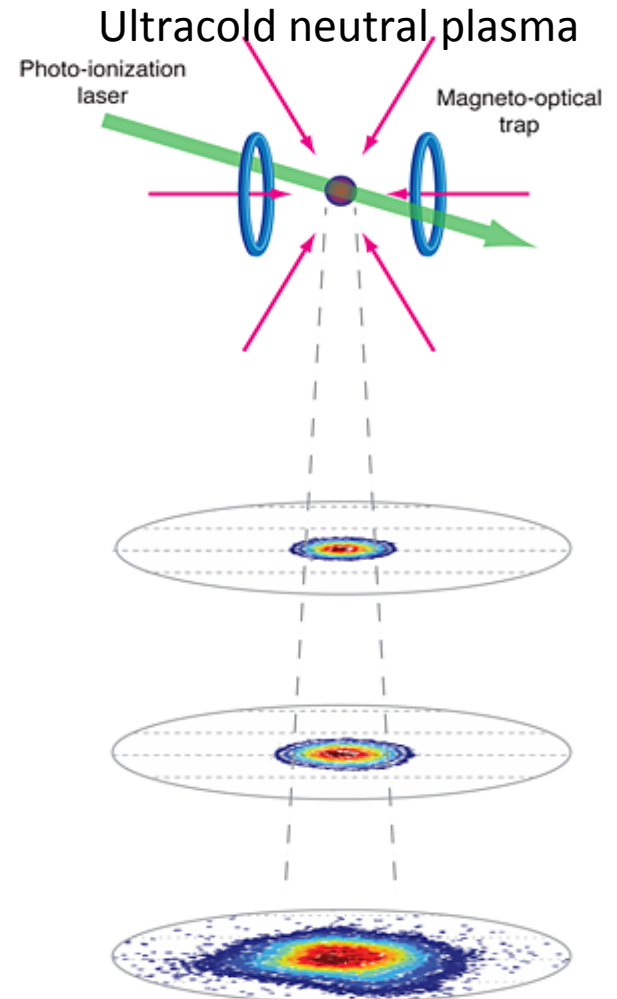
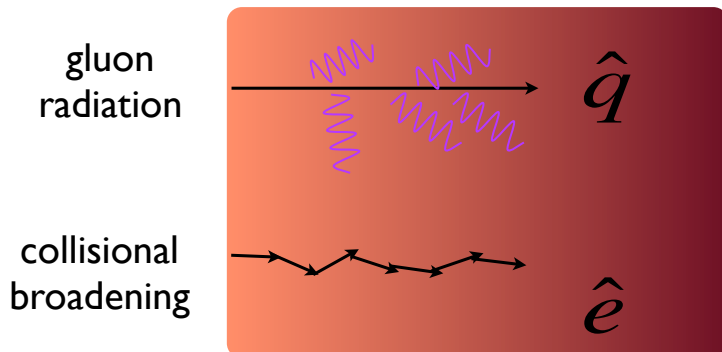
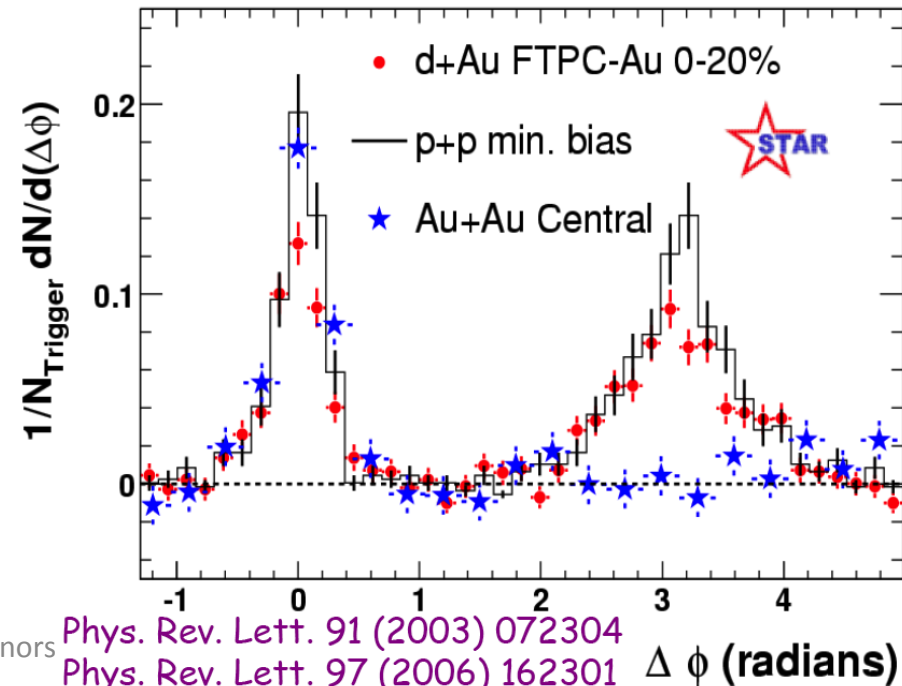
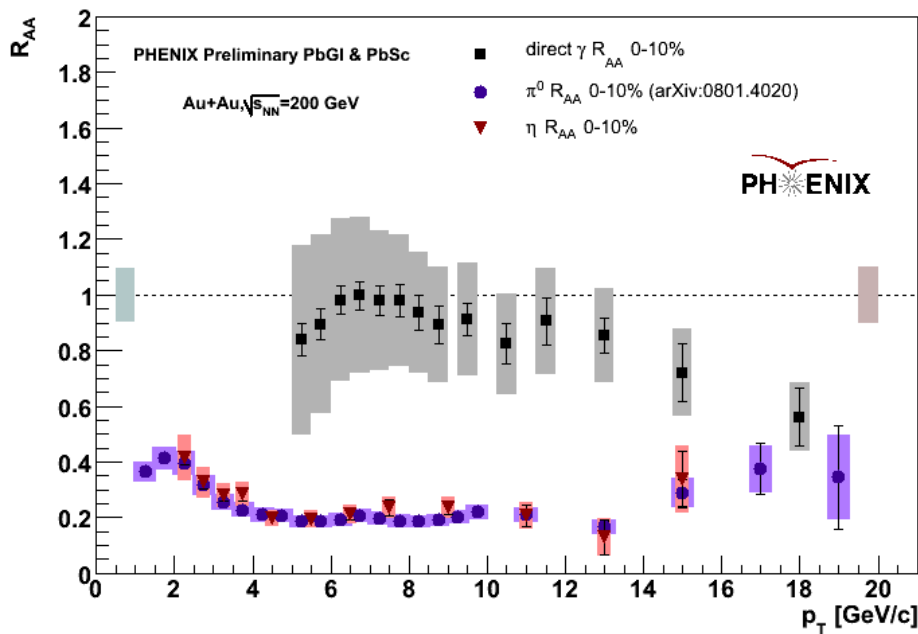

Illustration: [Alan Stonebraker](http://physics.aps.org/articles/v1/2) <http://physics.aps.org/articles/v1/2>

Jets are suppressed!

- Initial RHIC results used high p_T hadrons as a proxy for jets
- Suppression of high p_T hadrons observed \rightarrow Jet Quenching
- Direct photons do not interact via strong force; give $R_{AA}=1$
- Di-hadron away-side suppressed compared to pp and dAu



Megan Connors

Phys. Rev. Lett. 91 (2003) 072304

Phys. Rev. Lett. 97 (2006) 162301

$\Delta\phi$ (radians)

“T-Shirt Plot”

- Suppression also observed at LHC
- Electroweak probes give $R_{AA}=1$

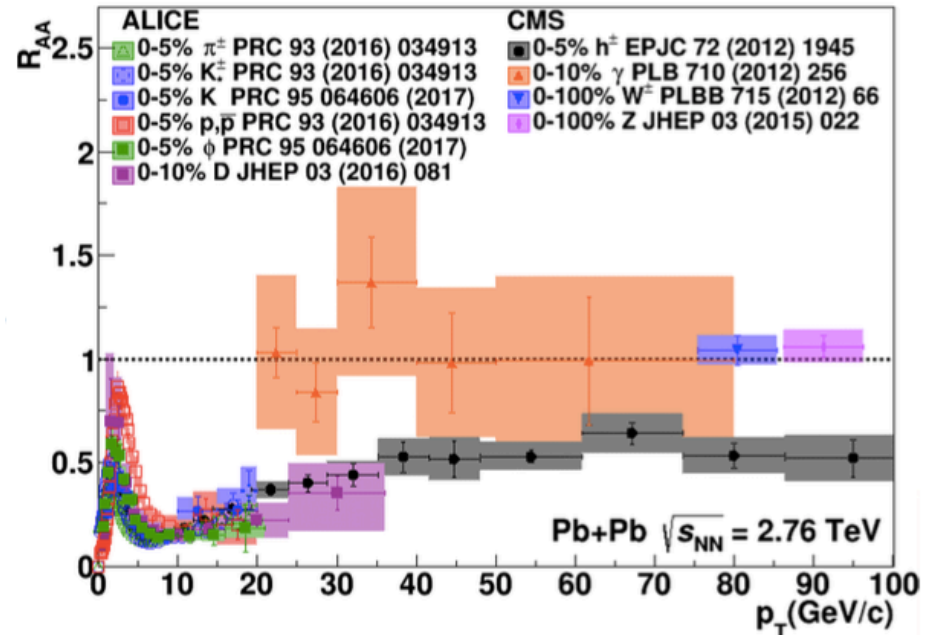
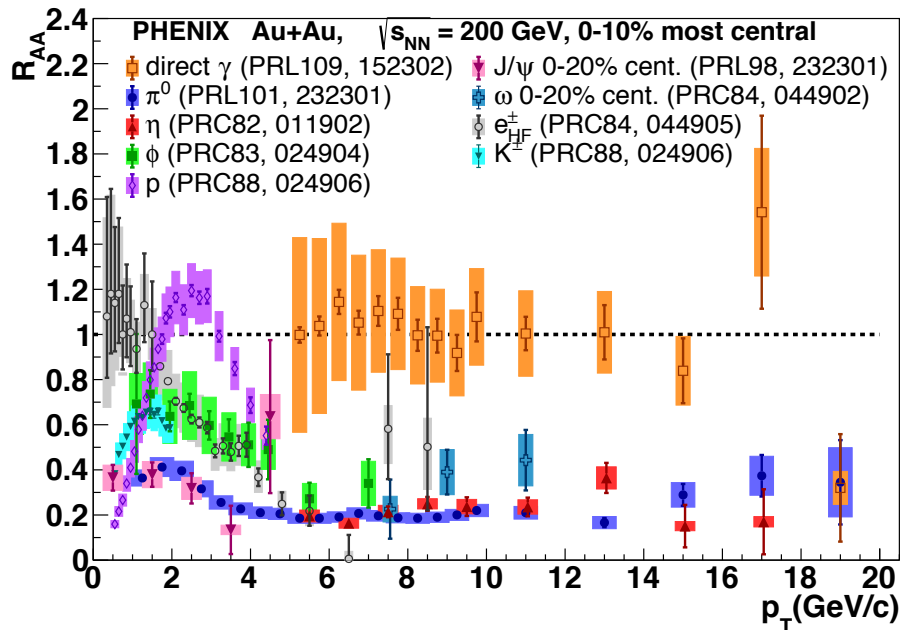

So What?

Questions for Jets in the QGP

Is the fragmentation pp like?

What is the effect of small systems on jets?

Where does the lost energy go?

What happens to dijet pairs?

How does temperature effect quenching?

Does the pathlength effect quenching?

Are jets effected by the medium?

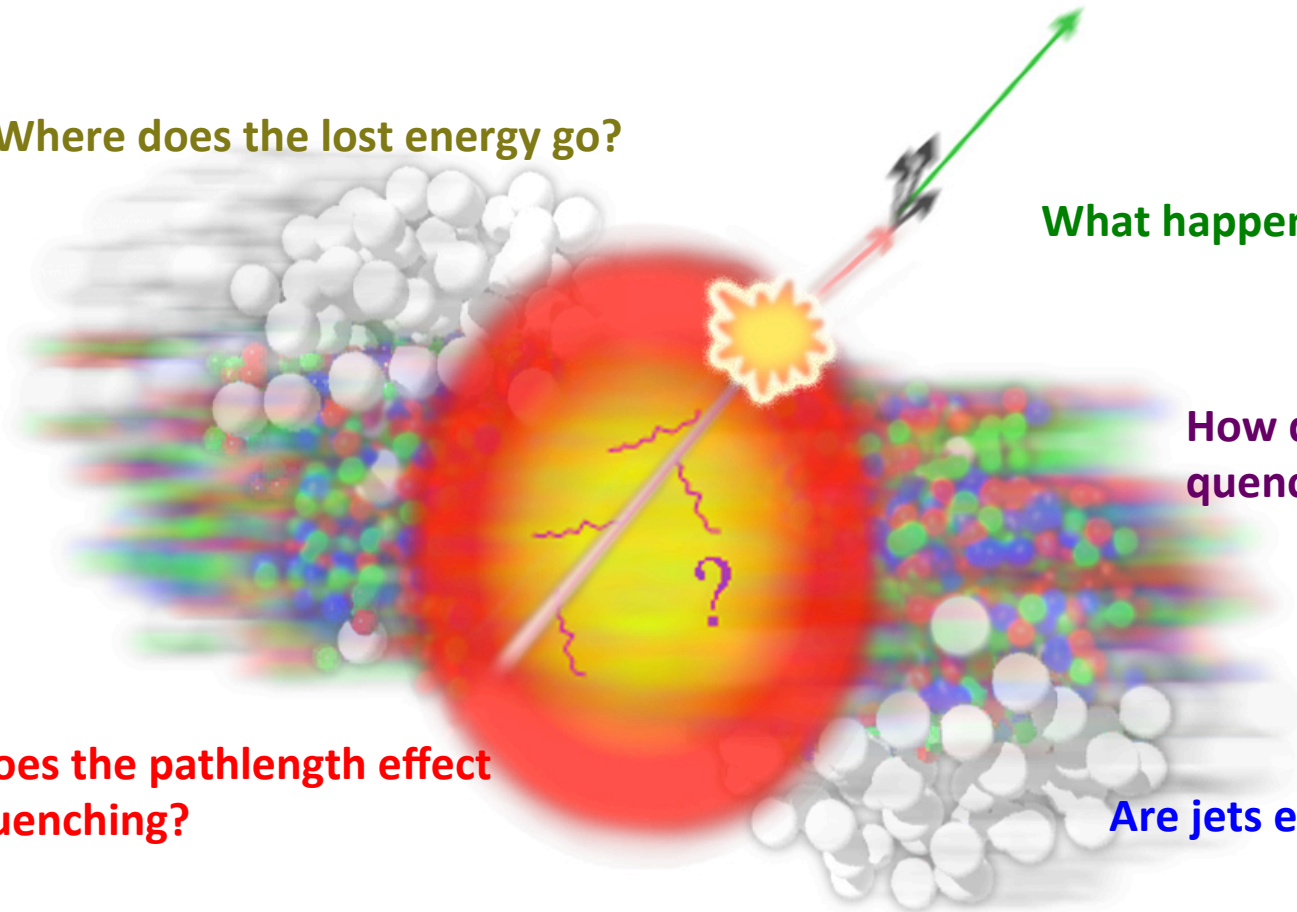

Collision System Dependence

- Pion suppression in a variety of collision species compared at similar N_{part}

Phys. Rev. Lett. 101, 232301

Phys. Rev. Lett. 101, 162301

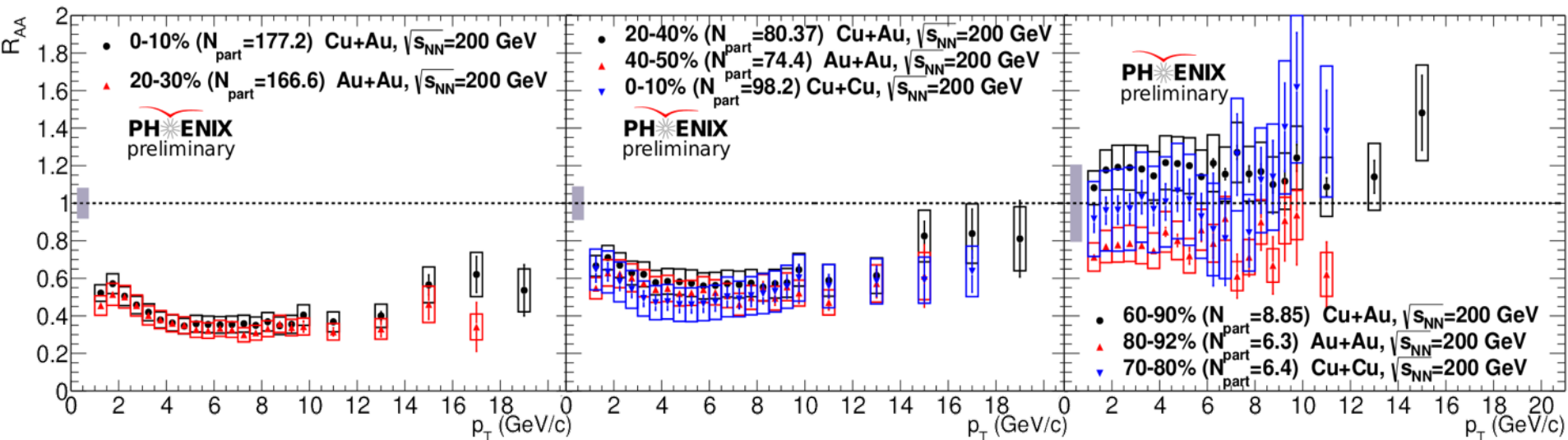

Energy Dependence

- Suppression effect not present at lower collision energies

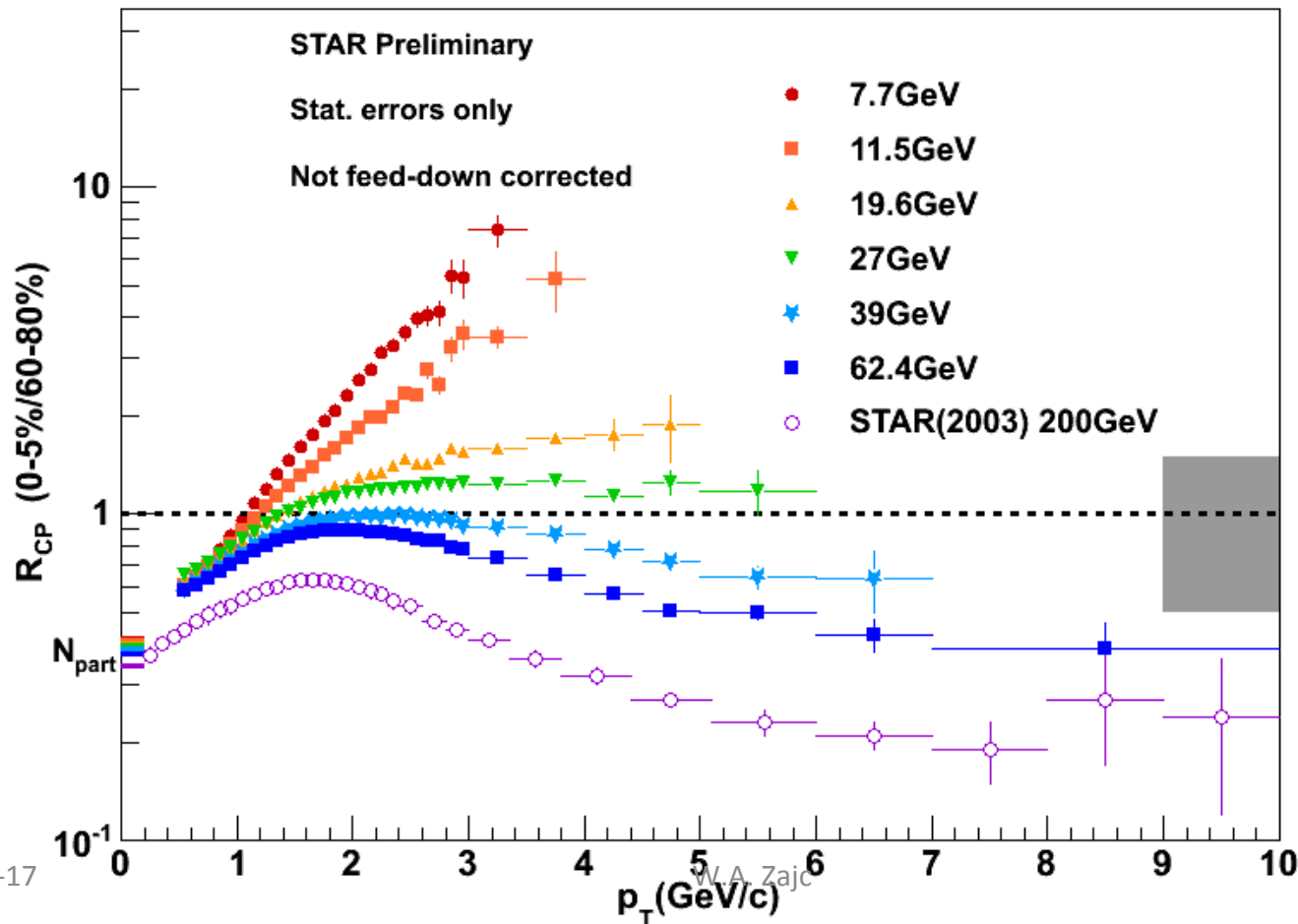

Energy Density Dependence

- Expect energy loss, $\Delta E/E$ to differ between RHIC and LHC
 - R_{AA} is insensitive to variations in energy loss
- Try fractional momentum loss $S_{loss} = \delta p_T / p_T$
- S_{loss} scales with energy density not geometry

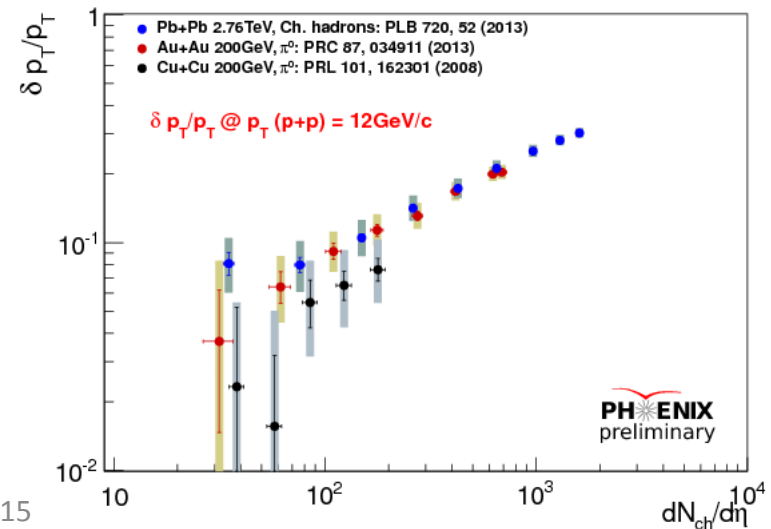
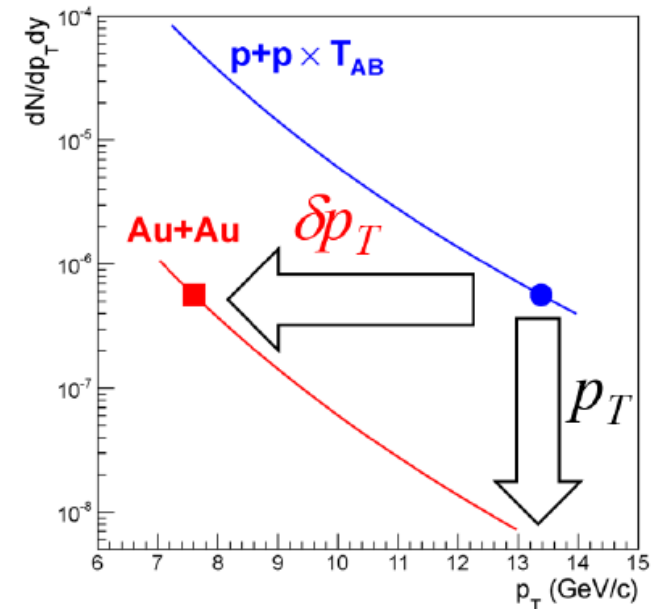

Pathlength Dependence at RHIC

PHENIX [Phys. Rev. C 76, 034904 \(2007\)](#)

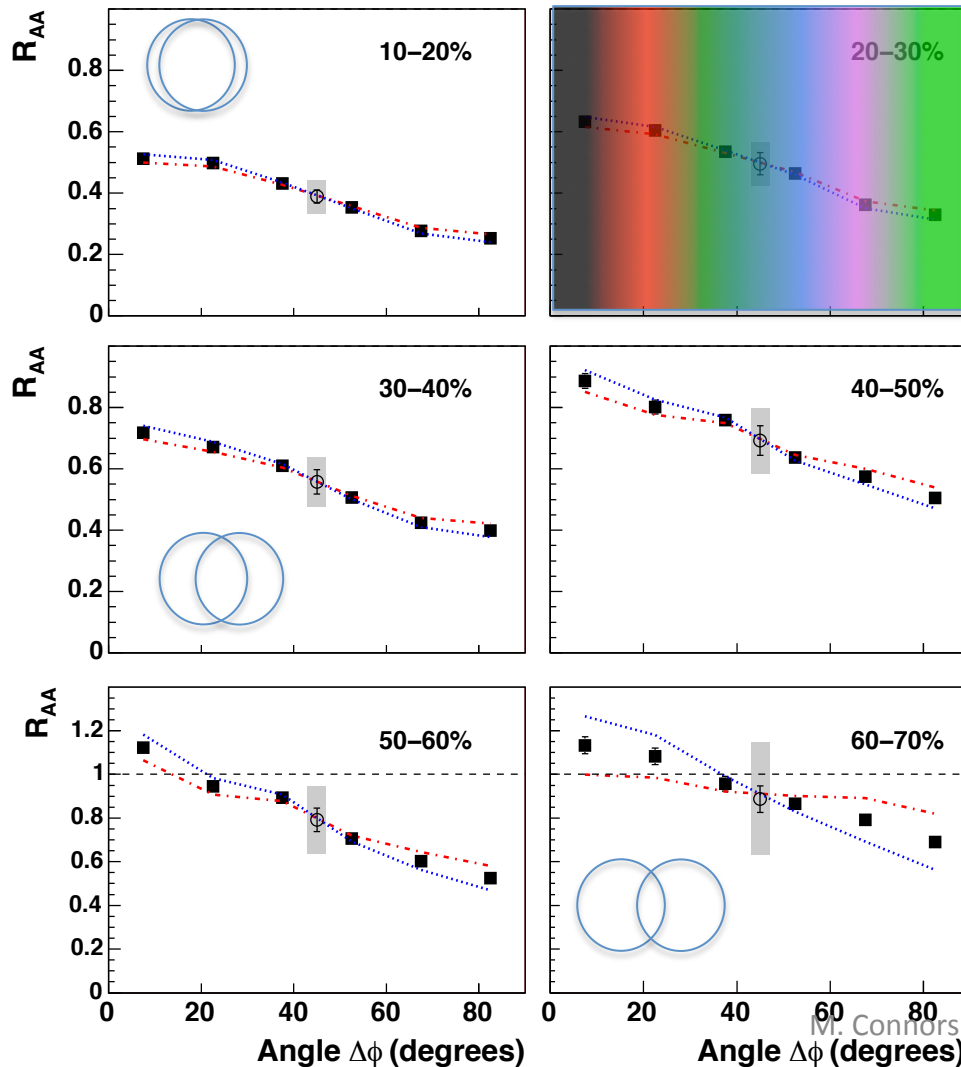

- Suppression of pions has pathlength dependence
- Toward out of plane:
 - Larger $L \rightarrow$ More Eloss

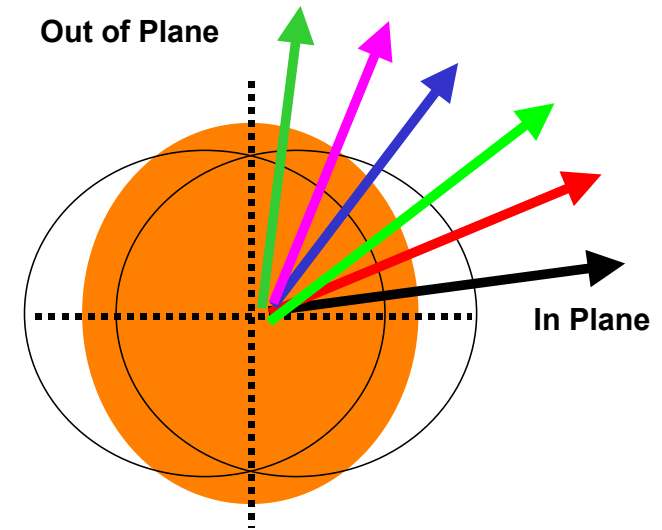

Relation between $R_{AA}(\varphi)$ and v_2 :

$$R_{AA}(\varphi) = R_{AA} (1 + 2v_2 \cos 2(\varphi - \psi))$$

Heavy Flavor Energy Loss

- Constrain models with R_{AA} and pathlength effect via v_2
- High p_T v_2 due to pathlength dependent energy loss

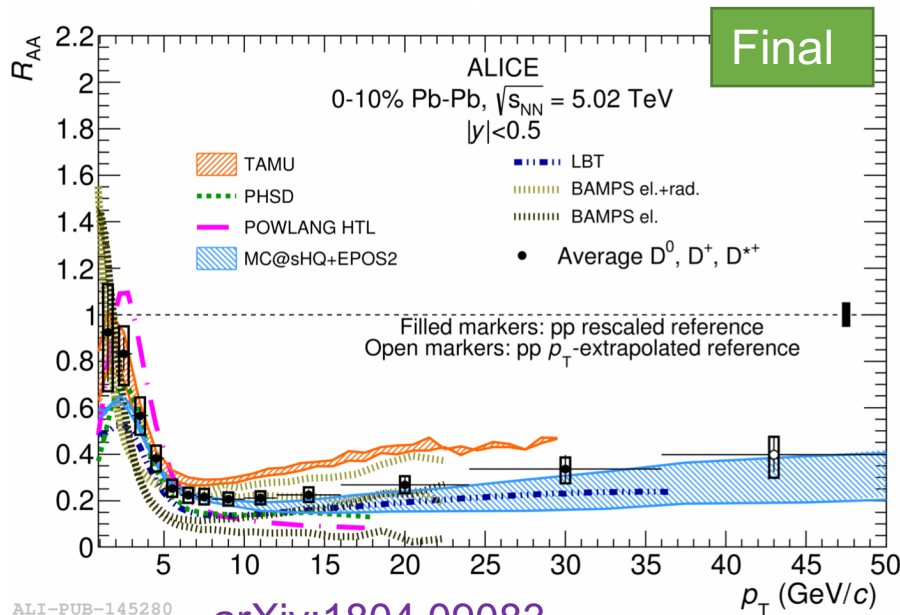

arXiv:1804.09083

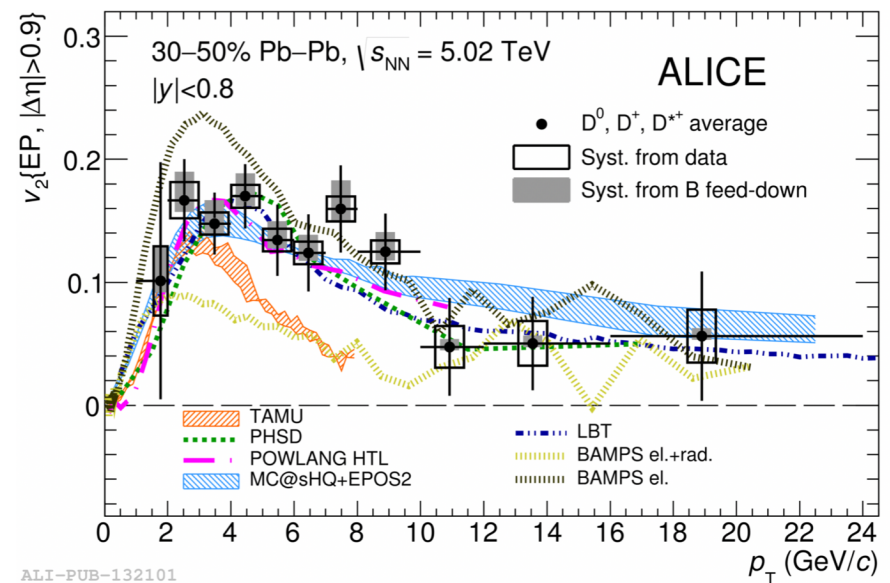

Jet Quenching

- R_{AA} for reconstructed jets also less than 1 out to high p_T
- Non-zero v_2 indicates pathlength dependent energy loss

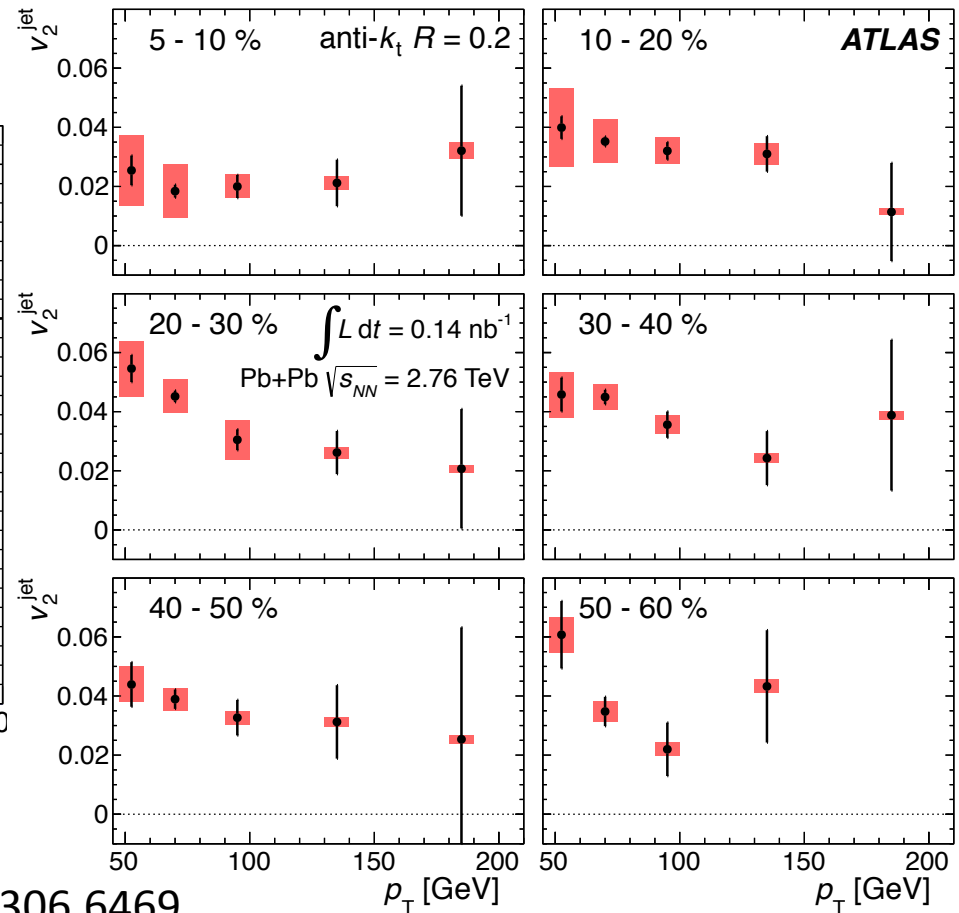
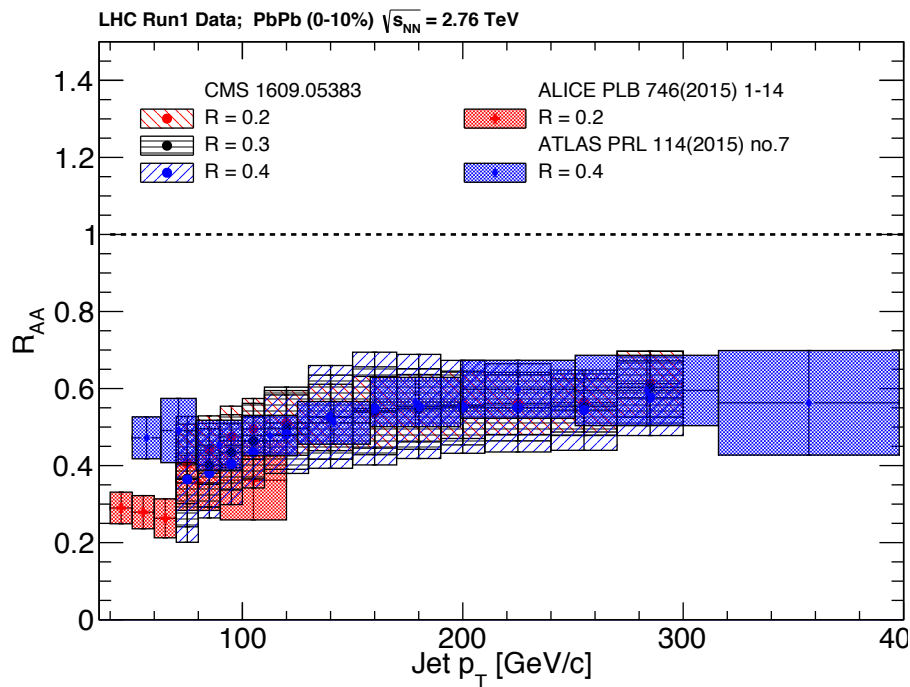

Pop Quiz

- Q. What is a proton?
- A. A particle comprised of valence quarks: 2 up and 1 down... Mass of ~ 938 MeV.... Stable for $>10^{29}$ years... spin of $\frac{1}{2}$...

the collimated spray of particles that results from the branching of the original hard parton and subsequent hadronization of the fragments

- Q. What is a Jet?
- A. It depends...
What's your definition?

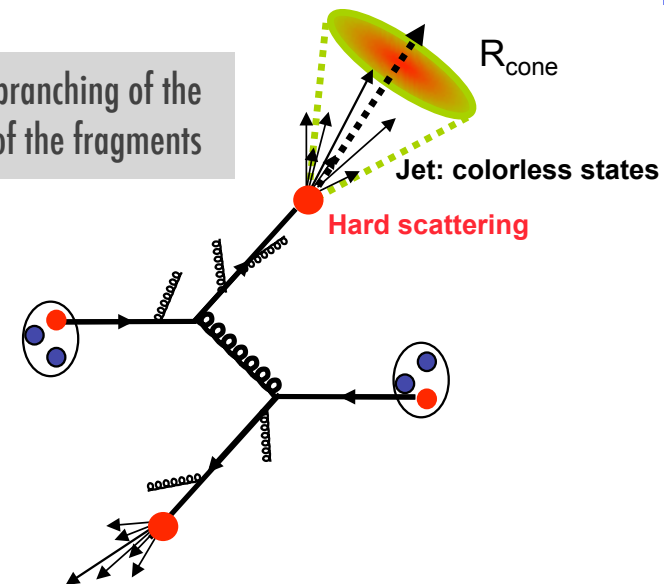

Jet Definition for QCD

- Snowmass Accord: fermilab-conf-90-249

ABSTRACT

In order to reduce uncertainties in the comparison of jet cross section measurements, we are proposing a standard jet definition to be adopted for QCD measurements involving light quarks and gluons. This definition involves the use of a cone in the $\eta - \phi$ metric with a radius of 0.7 units.

Several important properties that should be met by a jet definition are [3]:

1. Simple to implement in an experimental analysis;
2. Simple to implement in the theoretical calculation;
3. Defined at any order of perturbation theory;
4. Yields finite cross section at any order of perturbation theory;
5. Yields a cross section that is relatively insensitive to hadronization.

Tevatron 1990

Must also be stable even if:



collinear splitting

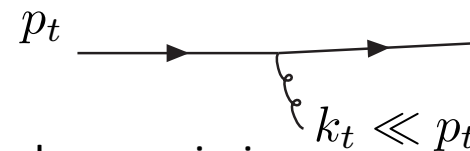

soft gluon emission

How to find jets

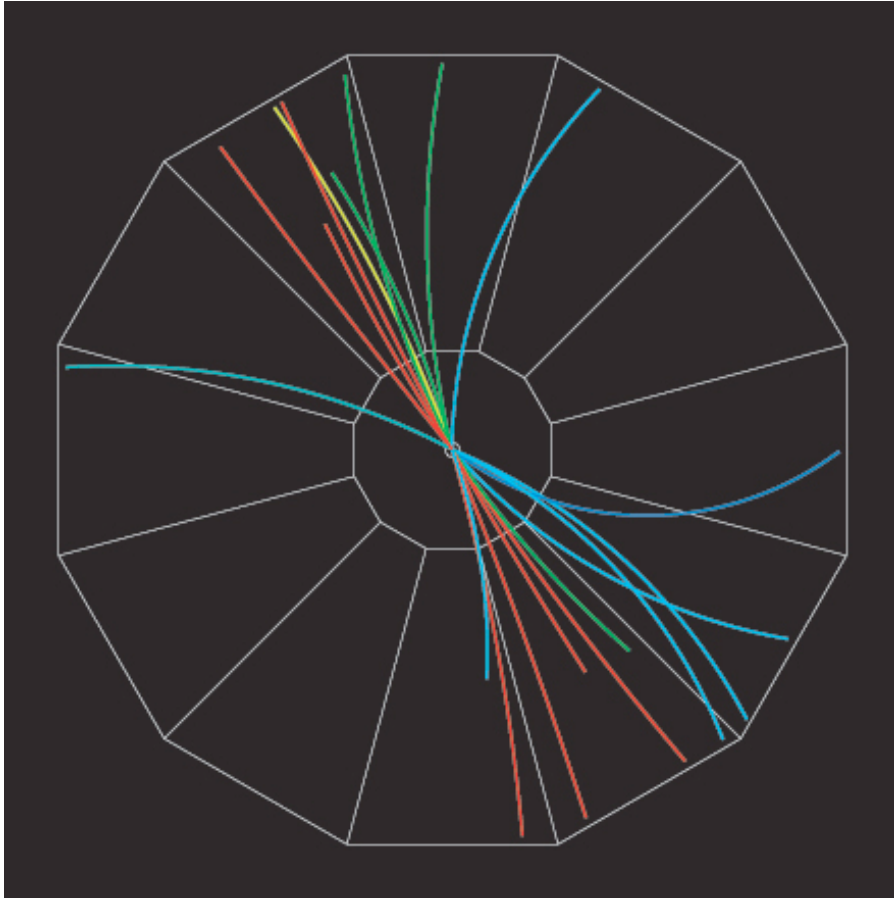

How many jets do you see?

How Many Jets are in Heavy Ion Collisions?

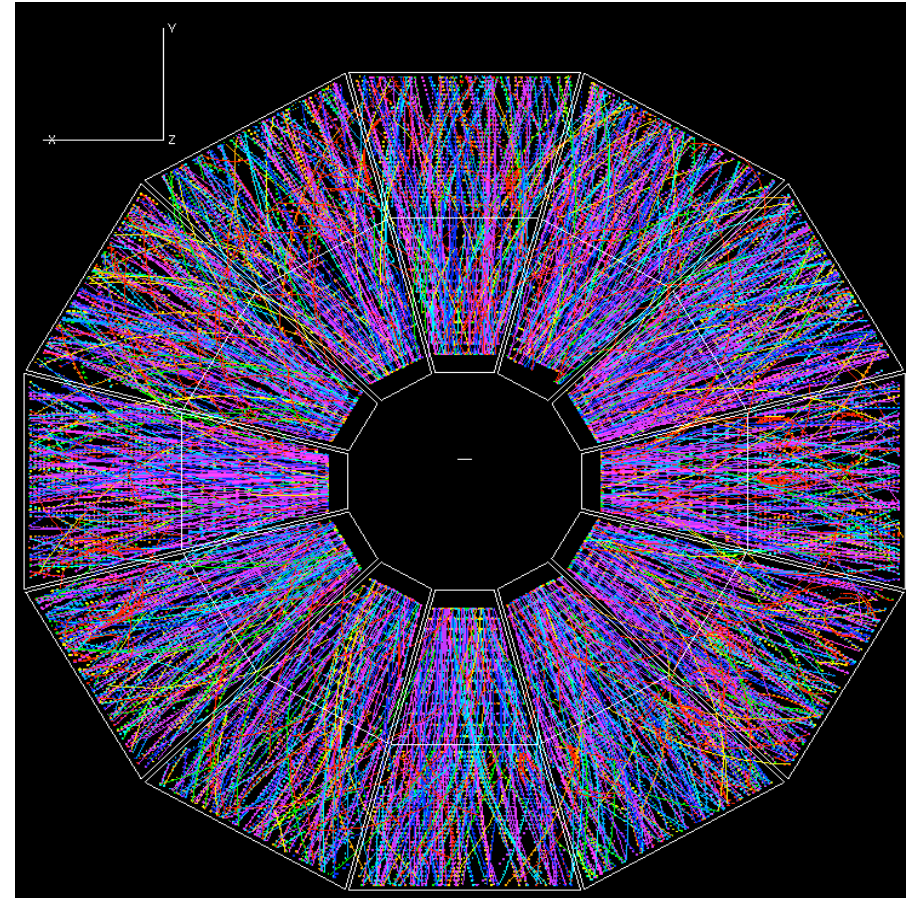
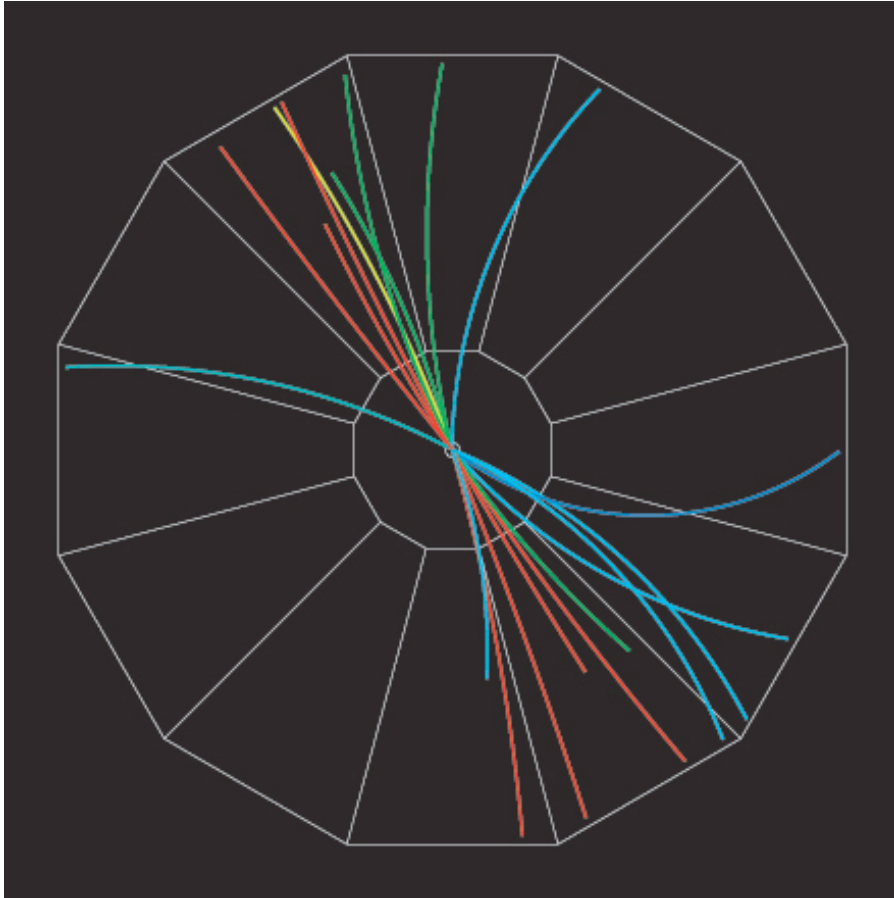

Maybe not so Crazy

- Jets boldly stand out of background at LHC
- Modification of di-jet balance visible

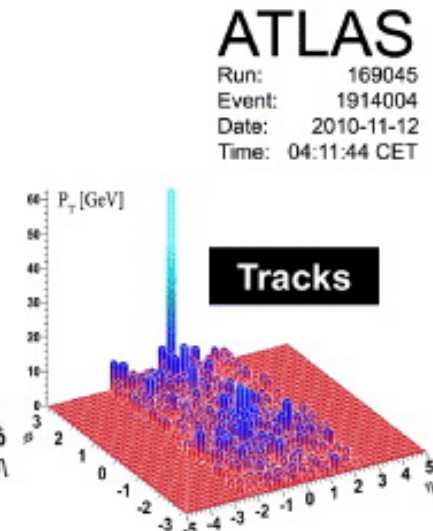
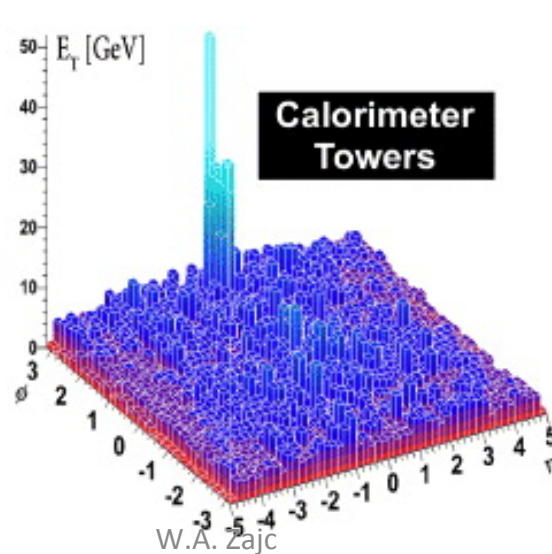
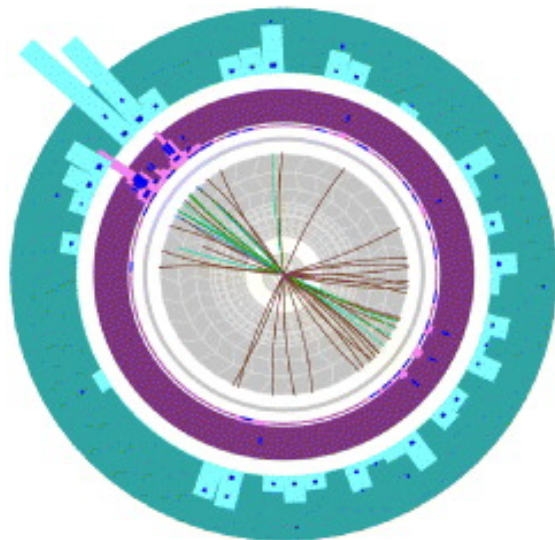
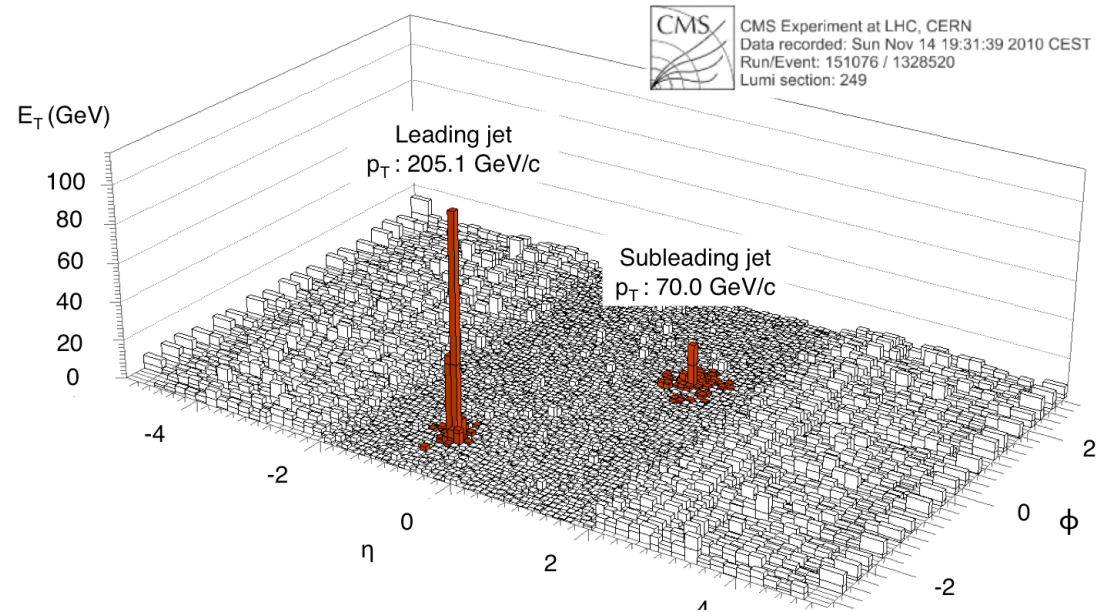

ATLAS
Run: 169045
Event: 1914004
Date: 2010-11-12
Time: 04:11:44 CET

Some Jet Finding Algorithms

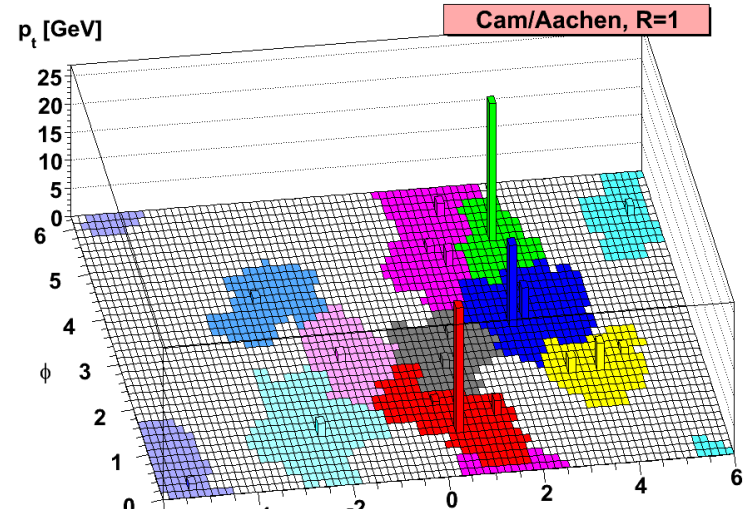
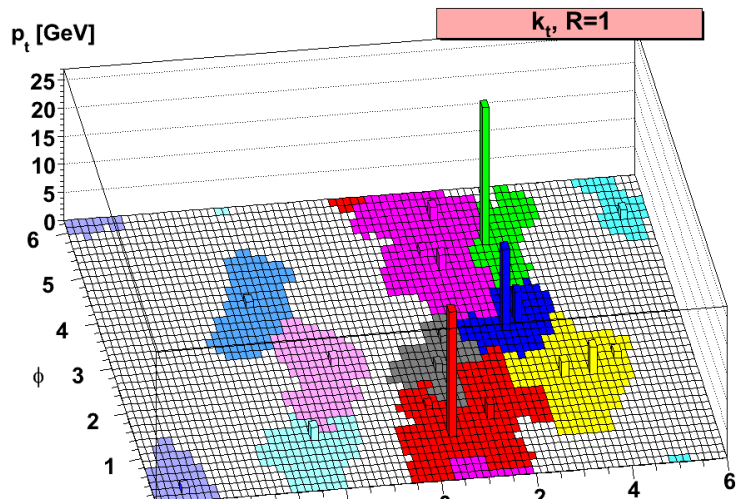

MC: proton-proton - single event

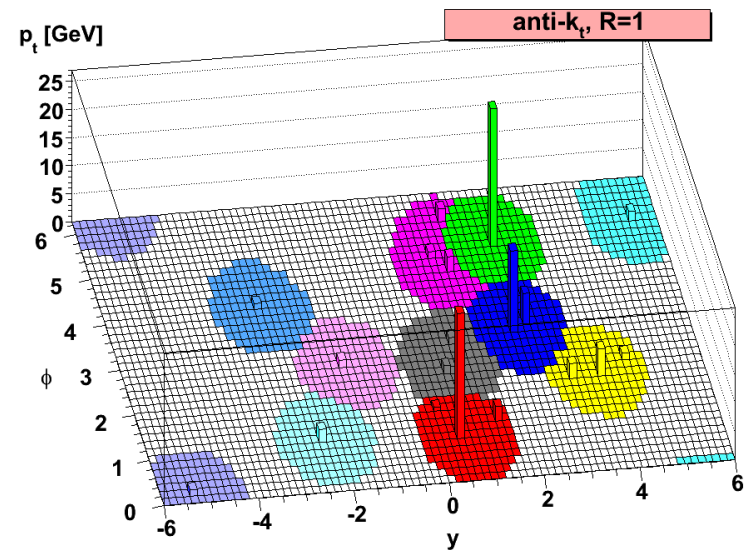
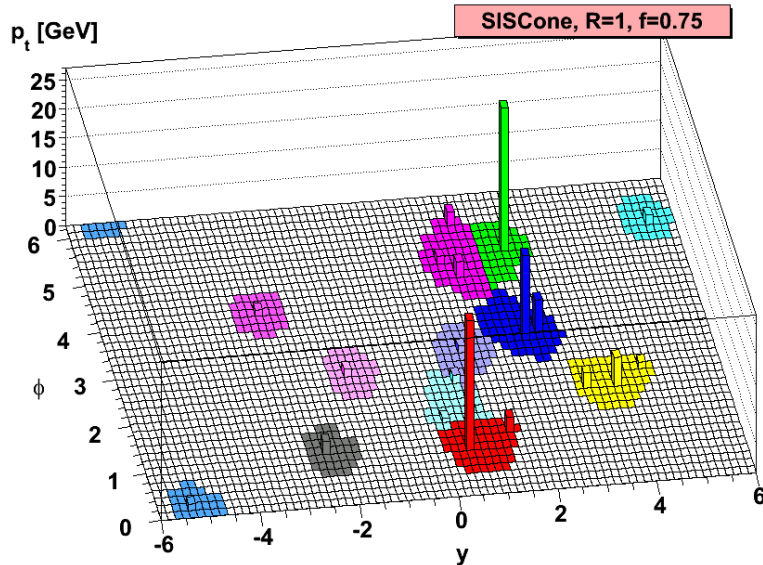

An Important Jet Finding Parameter

Small jet radius

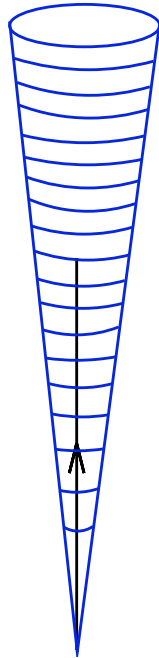

Large jet radius

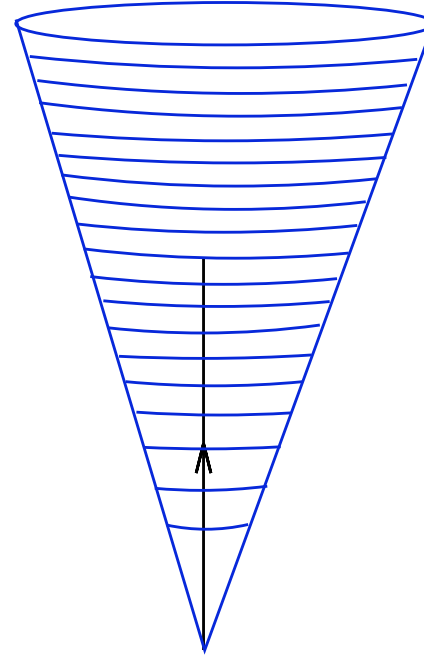

R

single parton @ LO: **jet radius irrelevant**

What R is better?

Small jet radius

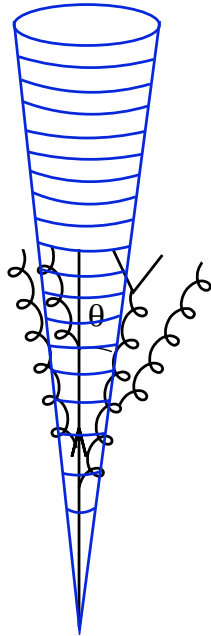

Large jet radius

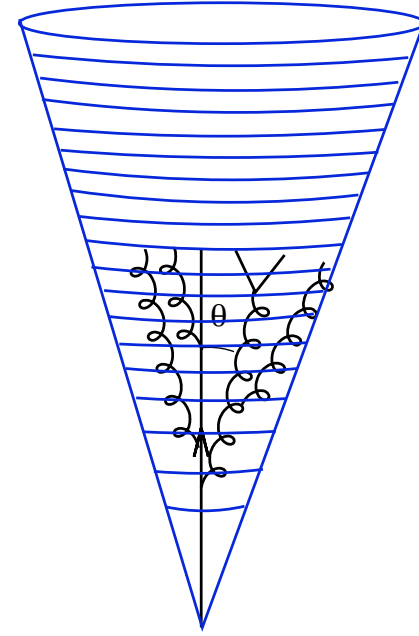

perturbative fragmentation: **large jet radius better**
(it captures more)

What R is better?

Small jet radius

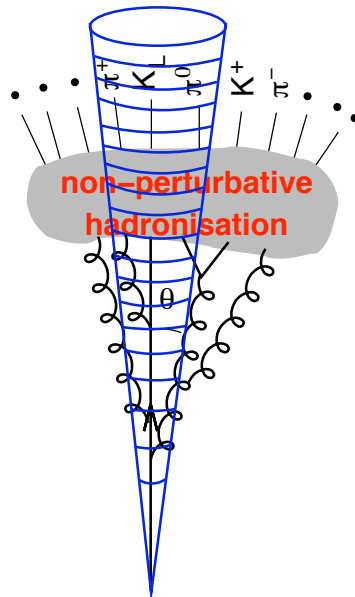

Large jet radius

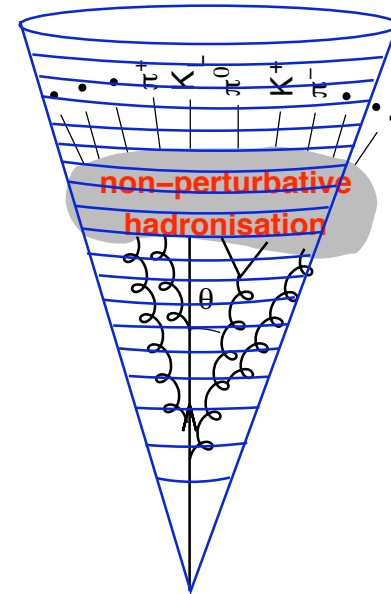

non-perturbative fragmentation: **large jet radius better**
(it captures more)

What R is better?

Small jet radius

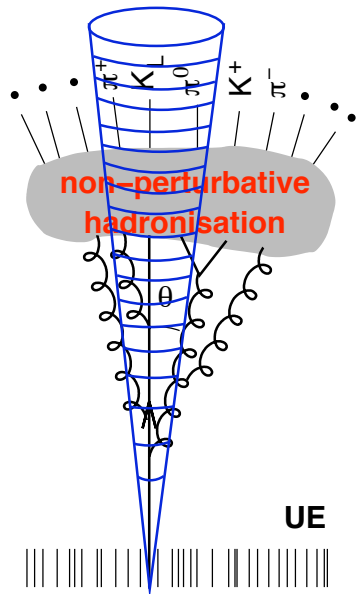

Large jet radius

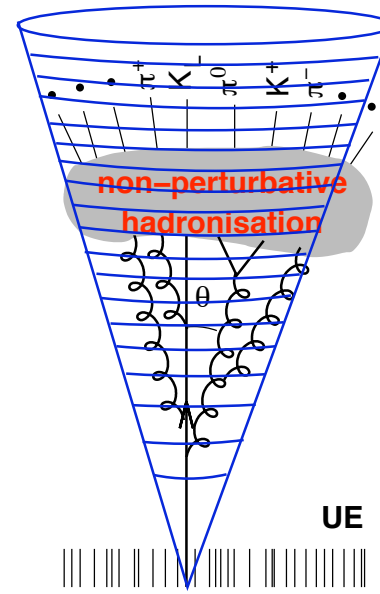

underlying ev. & pileup “noise”: **small jet radius better**
(it captures less)

Removing the Background

- Sometimes referred to as “fake jets” in PHENIX
- ALICE & STAR median ρ subtraction
- Iterative subtraction in η -rings
- Need to account for fluctuating background!

$$\rho = \text{median} \left(\frac{p_T^{jet,i}}{A_i^{jet}} \right)$$

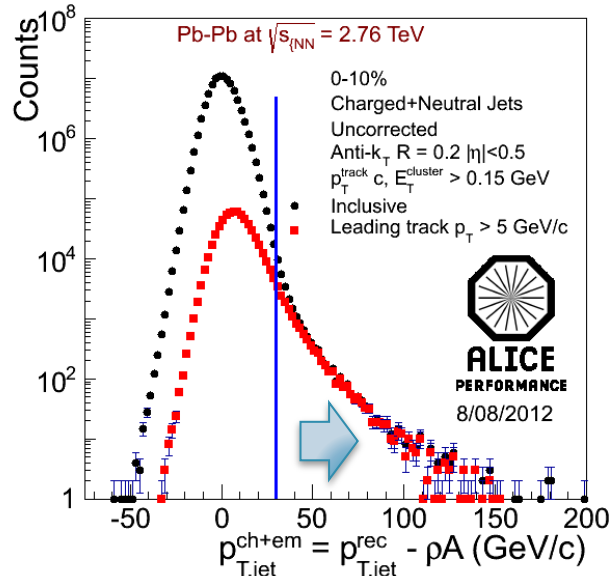
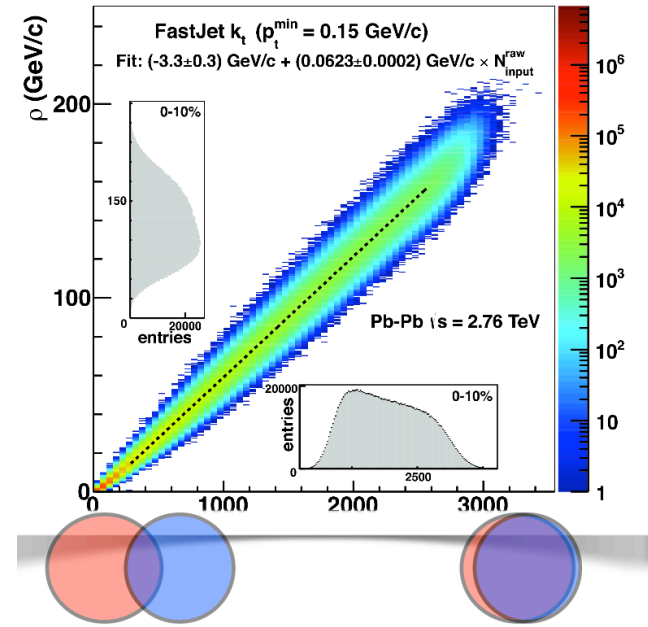

Unfolding

- PYTHIA jets through GEANT of your detector to make a response matrix to map detector jet to truth jet p_T
- Unfolding methods: Bayesian, SVD, χ^2 (bin by bin)

$$y_j^{reco} = \sum_{i=0}^N R_{ij} y_i^{true} \quad y_i^{true} = \sum_{j=0}^N R_{ij}^{-1} y_j^{reco}.$$

How to Measure Jets

- Measure your particles
- Choose your Algorithm and R
- Run FastJet
- Measure your background and remove it from your jets
- Unfold for detector effects
- Obtain a fully corrected jet spectrum

Di-Jets

- Dijet Asymmetry

$$A_J \equiv \frac{E_{T1} - E_{T2}}{E_{T1} + E_{T2}}$$

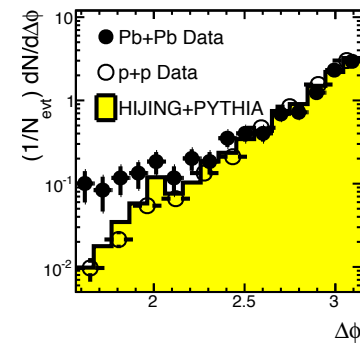
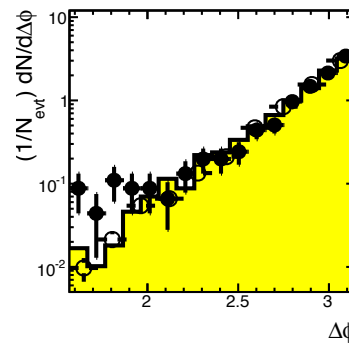
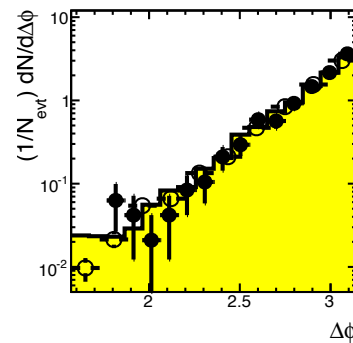
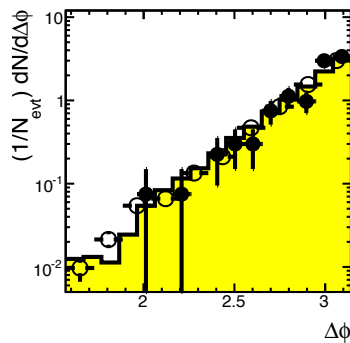
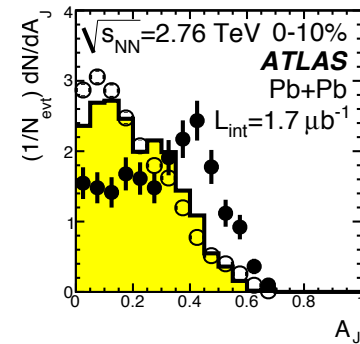
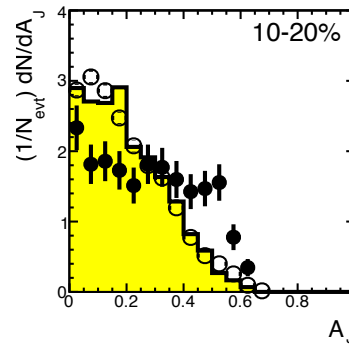
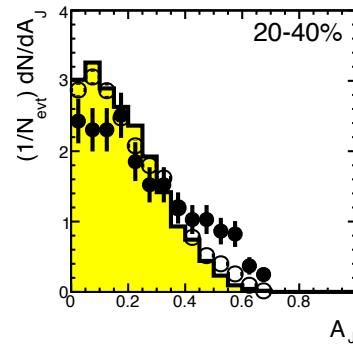
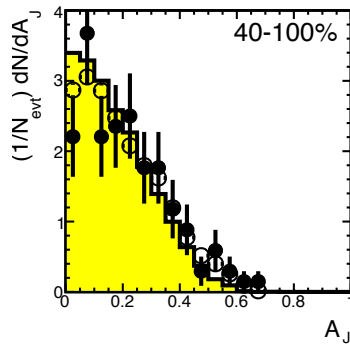
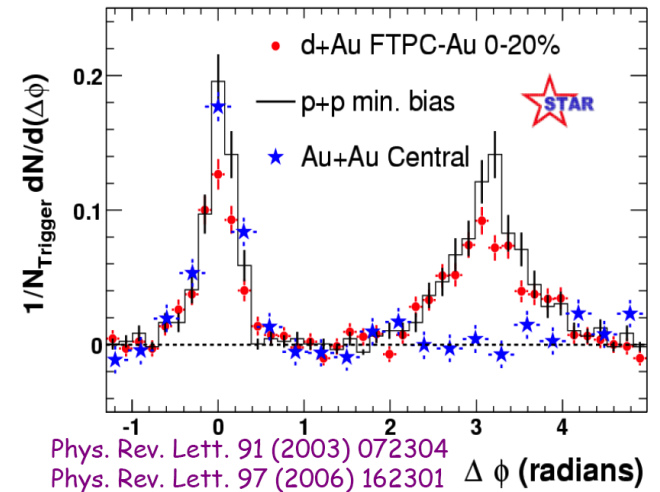

pQCD Factorization

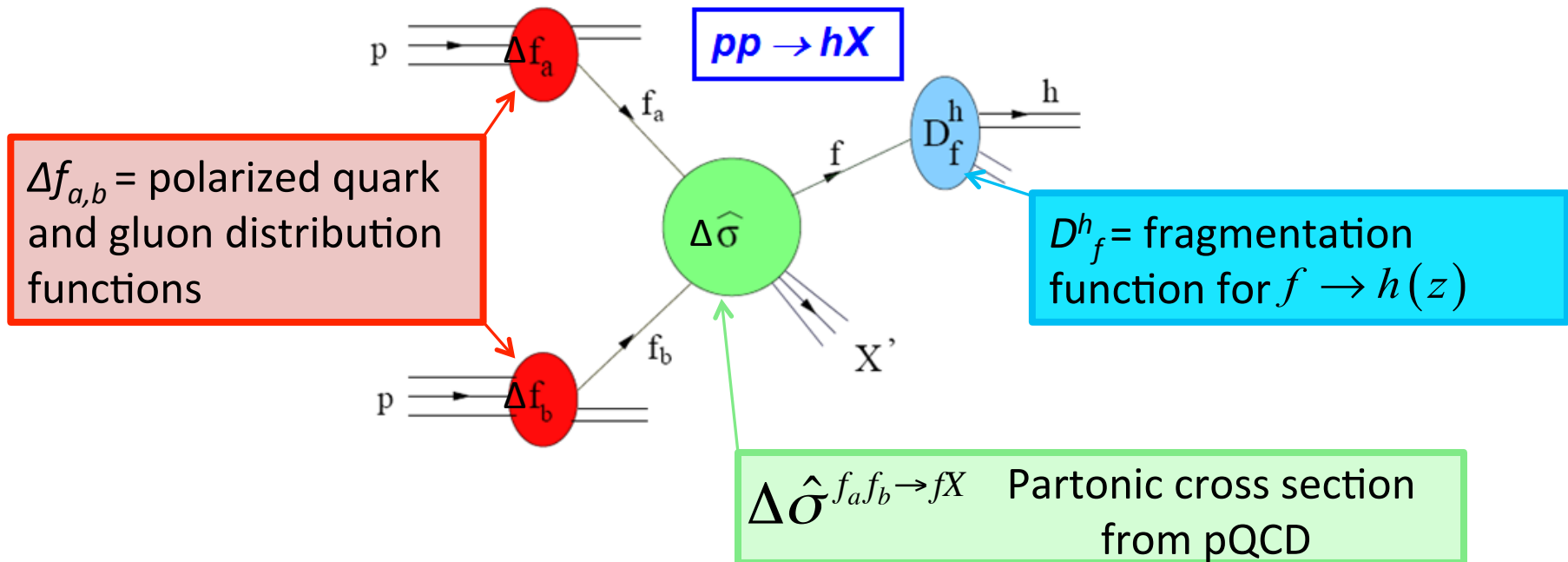

$$\Delta \sigma_{pp} = \sum_{a,b} \Delta f_a \otimes \Delta f_b \otimes \Delta \hat{\sigma}^{f_a f_b \rightarrow f X} \otimes D_f^h(z)$$

Initial State
n PDF

pQCD

Final State
 ΔE

Jets at the LHC

- Fragmentation functions with modified jets
- $z = p_{Th} / p_{Tjet}$

CMS Phys. Rev. C 90, 024908

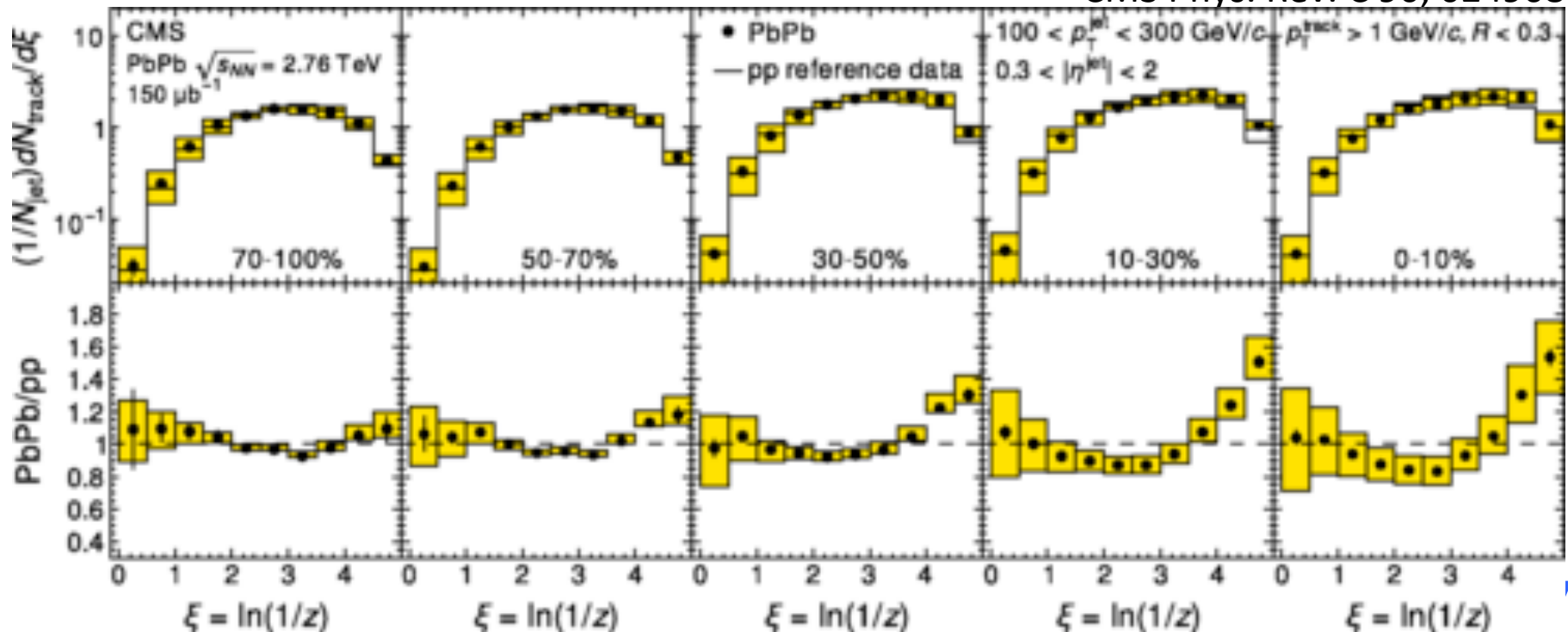

Studying Jets in Heavy Ion Collisions

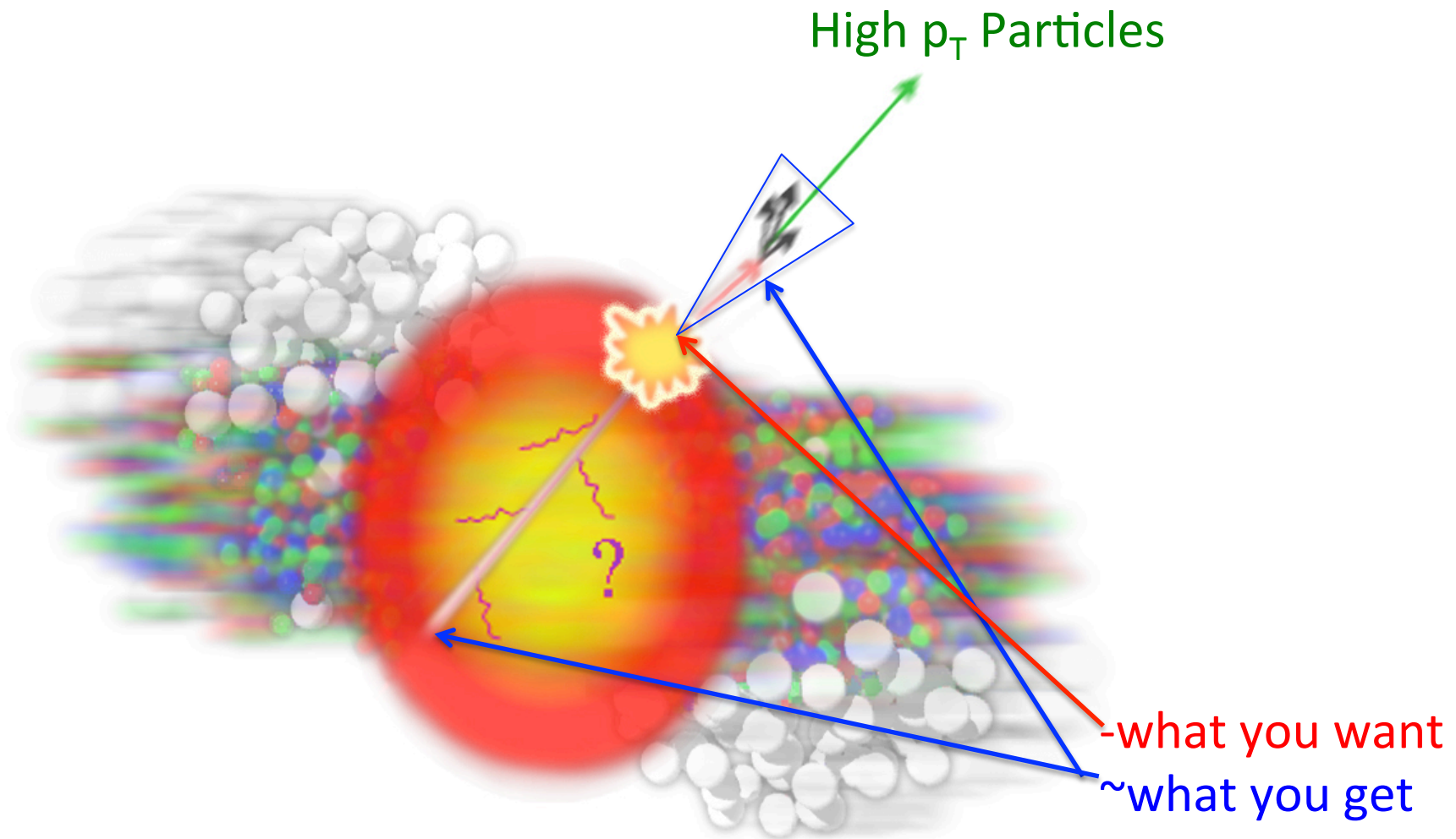

Photon Tagged Jets

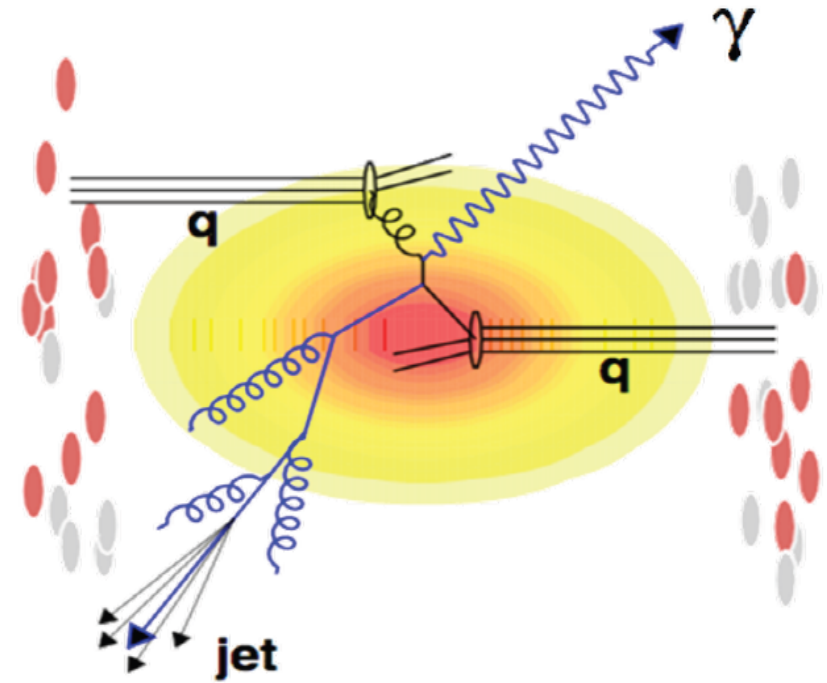
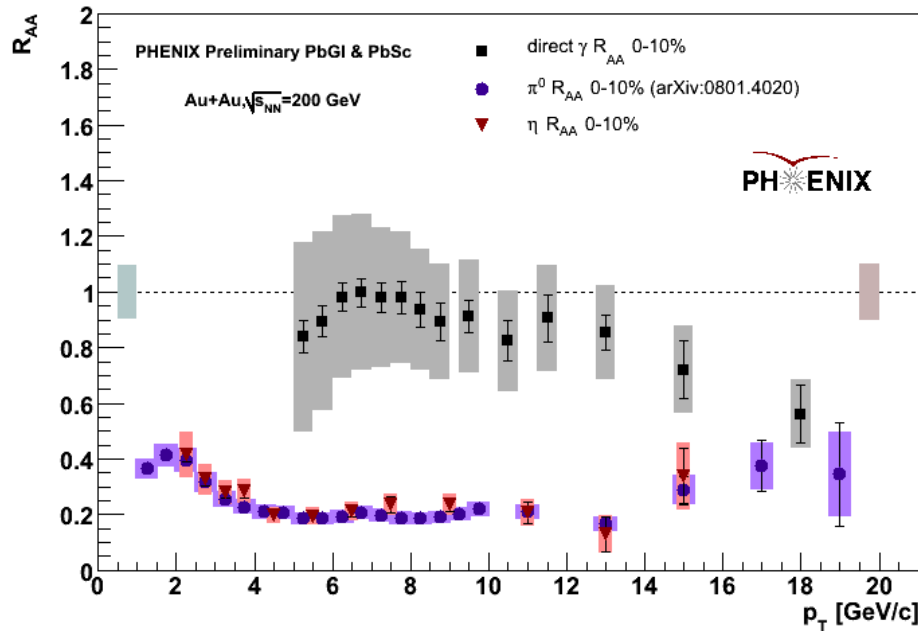

- Photons do not interact strongly
- $R_{AA} \approx 1$ implies no medium effect
- Fragmentation Function: dN/dz
 - $z = p_h / p_{jet}$

$\gamma \text{ energy} \approx \text{jet energy}$

Measurements with Jet Probes

Spectra and R_{AA}

- Is AA just a superposition of pp collisions?

$$R_{AA} = \frac{dN_{jet}^{AA} / dp_T}{\langle N_{coll} \rangle dN_{jet}^{pp} / dp_T} \frac{N_{evt}^{pp}}{N_{evt}^{AA}}$$

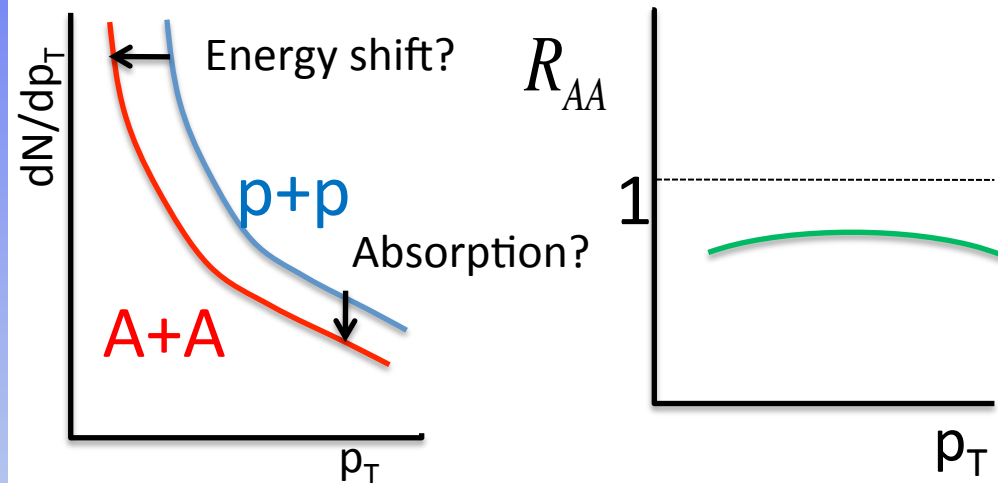

Correlations

- Energy deposition as a function of angle

$$I_{AA} = \frac{Y_{AA}}{Y_{pp}}$$

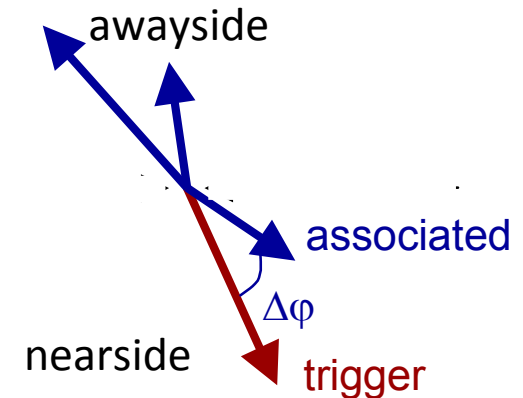

γ -h correlations: Fragmentation Function

$$p_T^\gamma \approx p_T^{jet} \quad z_T = \frac{p_T^h}{p_T^\gamma} \quad \Longrightarrow \quad D_q(z_T) = \frac{1}{N_{evt}} \frac{dN(z_T)}{dz_T}$$

- Photon p_T approximates parton/jet p_T
 - potential imbalance due to k_T
- Modified Fragmentation function
- Selects quark jets
 - pp results consistent with TASSO measure of quark FF
- Modified FF in Au+Au

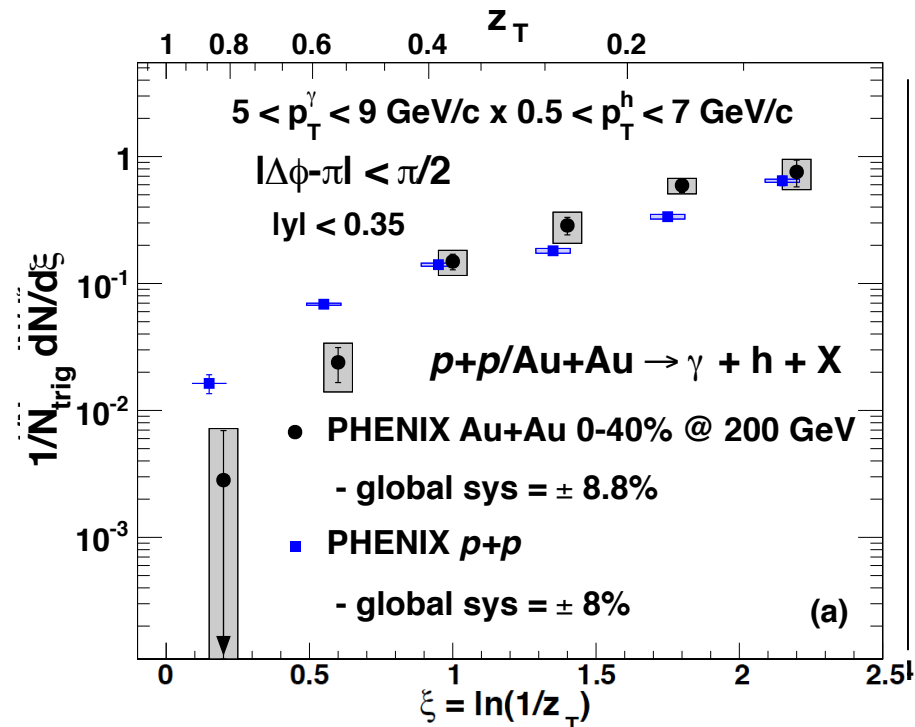
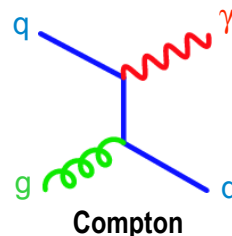

PRL 111, 032301

γ -h correlations: FF Modification

- I_{AA} quantifies the FF modification
- Suppression at low ξ and enhancement at high ξ
- Qualitative agreement with models
 - Similar conclusion from STAR jet-h results
- More enhancement at wider angles
- LHC can study effect at higher s_{NN} and access higher parton energies

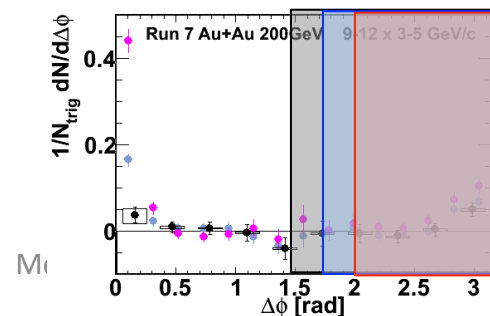
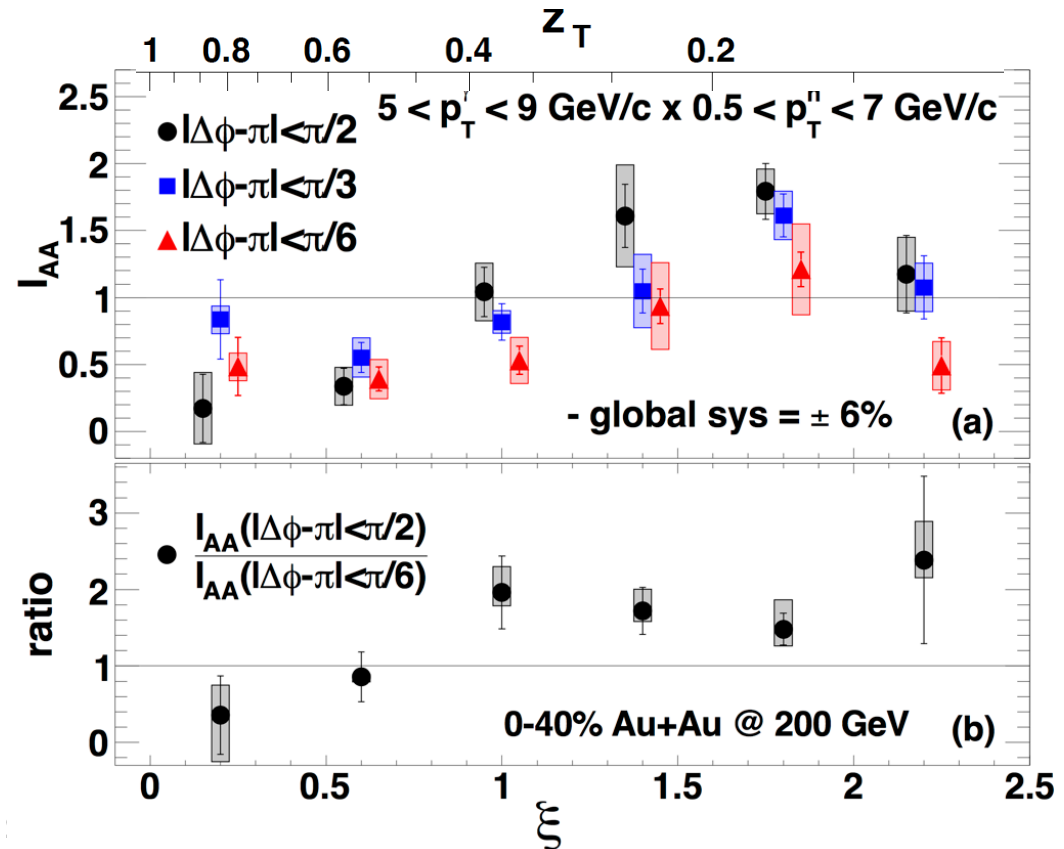

Phenix PRL 111, 032301

Studying Jets in Heavy Ion Collisions

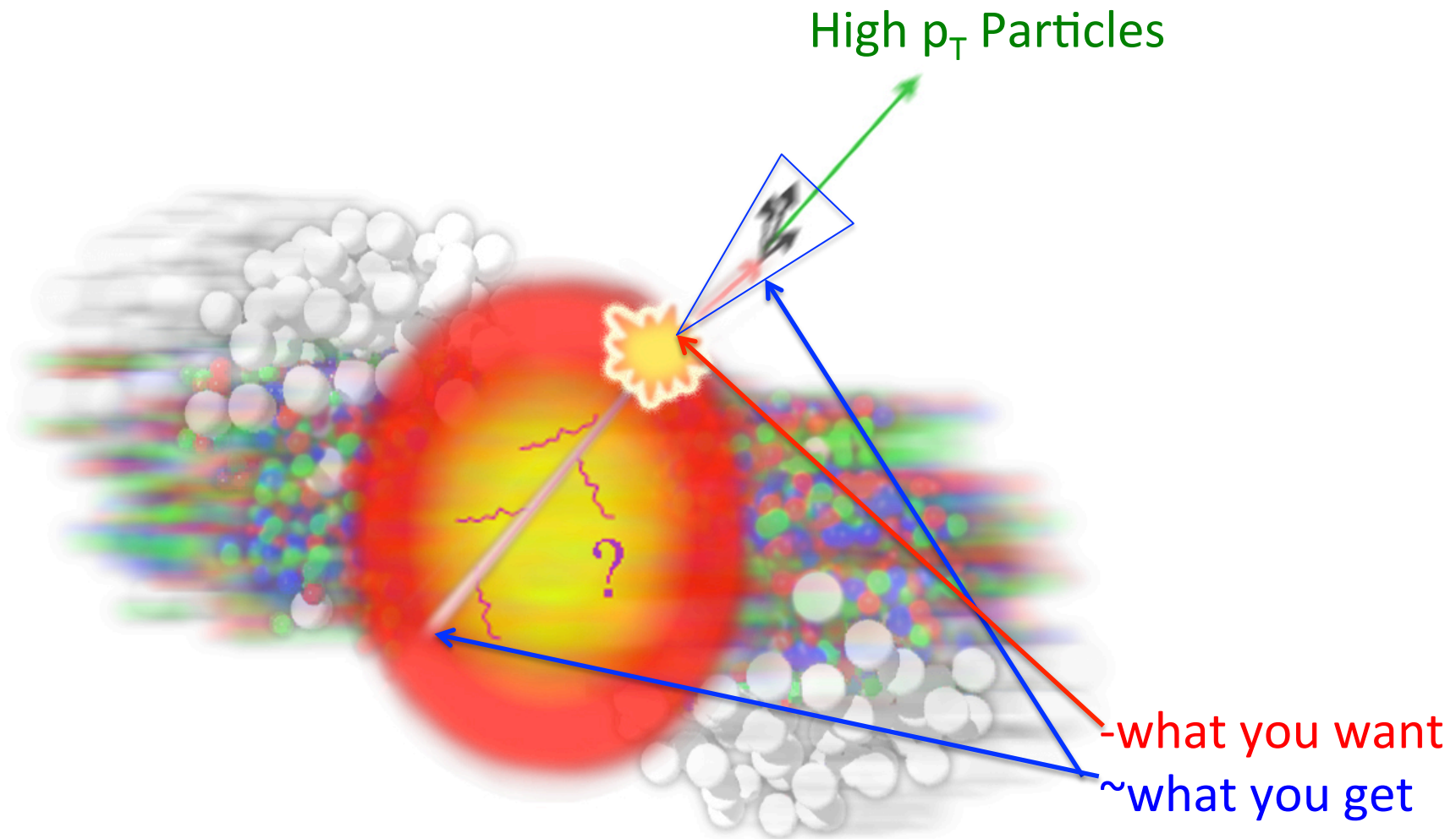

Photon Tagged Jets at the LHC

- Exciting to see these measurements achieved

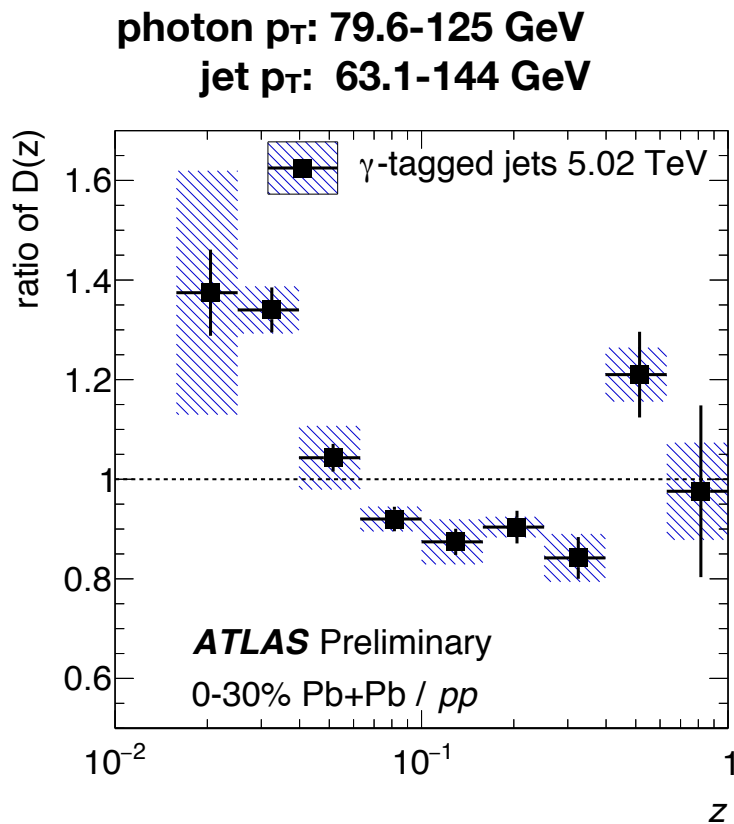

photon p_T : > 60 GeV
jet p_T : > 30 GeV

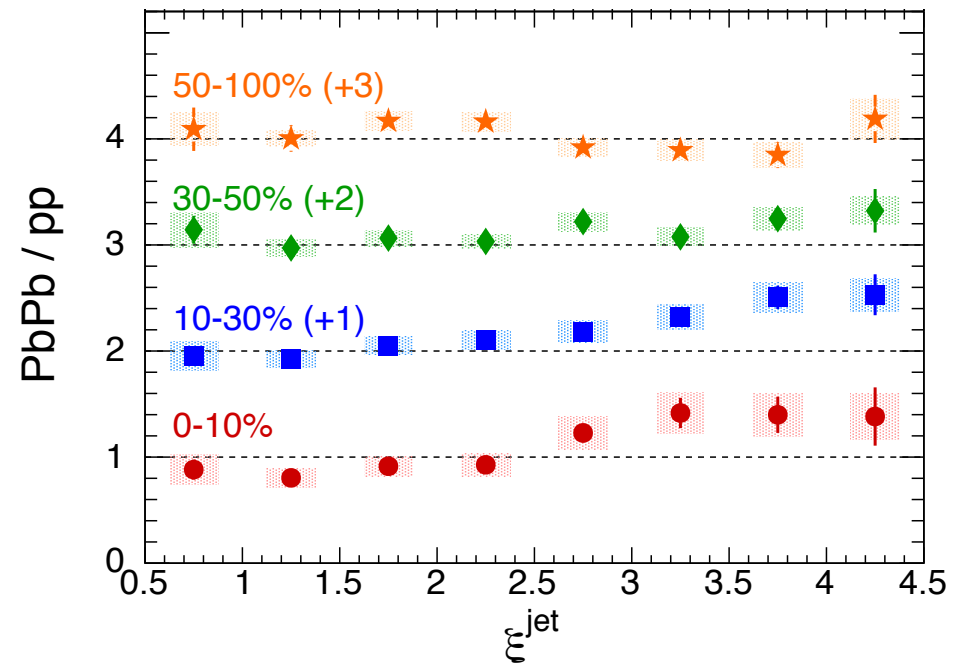

Cold Nuclear Matter Effects on Jets

- MinBias dAu consistent with pp
- Interesting centrality dependence observed

PHENIX PRL 116, 122301 (2016)

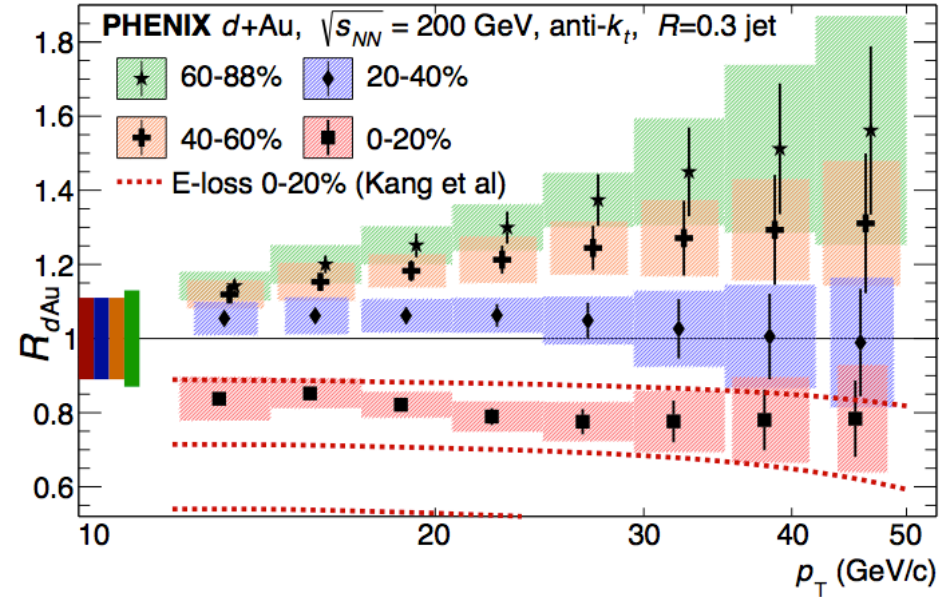
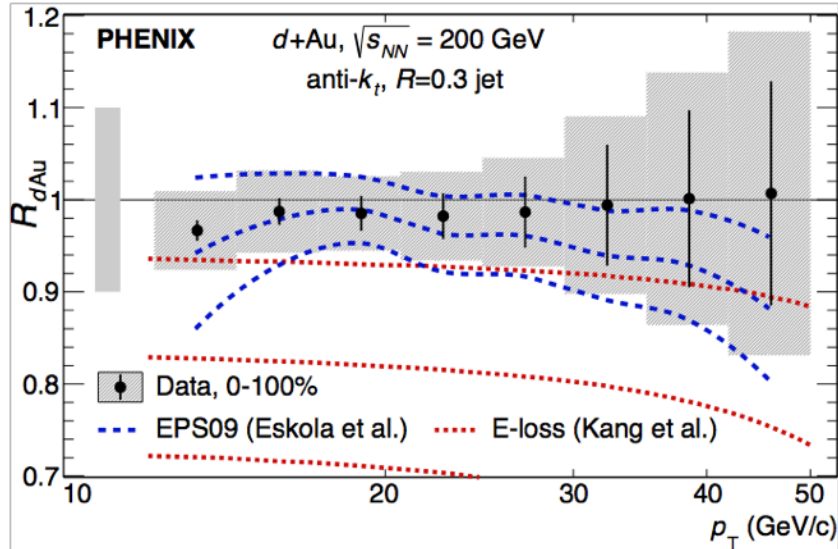

Pions in small systems

- Pions in small systems also show similar effect
- Theoretical explanations: shrinking proton and others...not final state energy loss effect

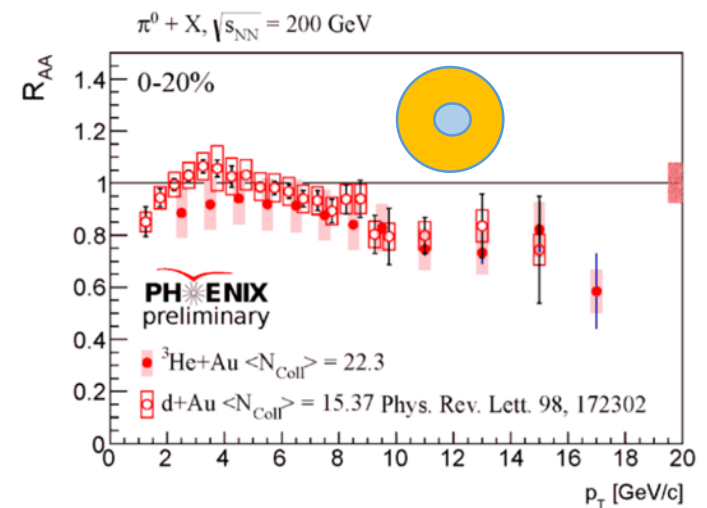
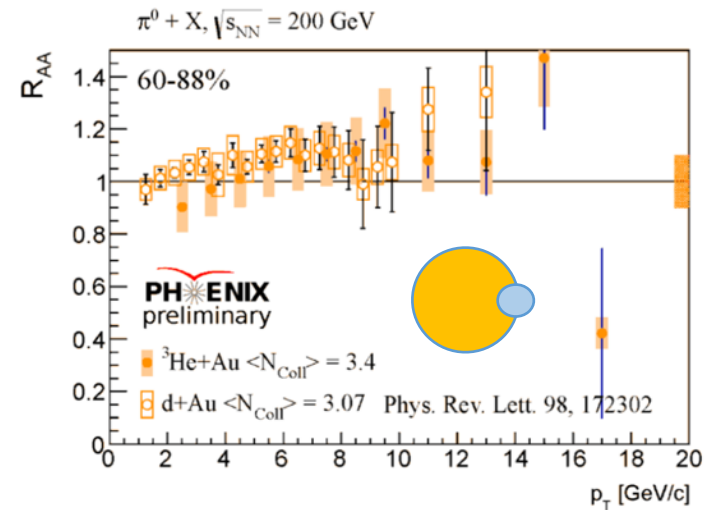

nPDF

- Increased statistical precision of data is providing more powerful constraints on nPDF

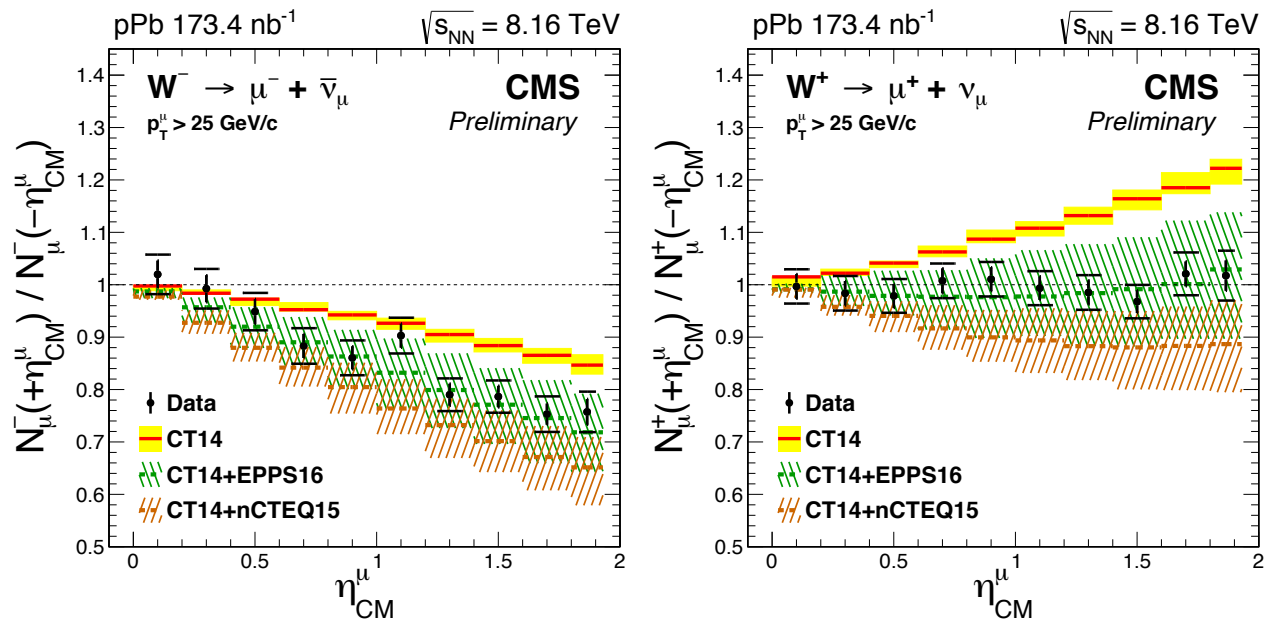

Where does the lost energy go? LHC

$$\rho(r) = \frac{1}{\delta r} \frac{1}{N_{\text{jets}}} \sum_{\text{jets}} \frac{\sum_{\text{tracks} \in (r_a, r_b)} p_T^{\text{track}}}{p_T^{\text{jet}}}$$

- Shows enhanced particles out to 1 radian

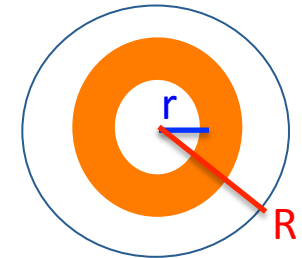
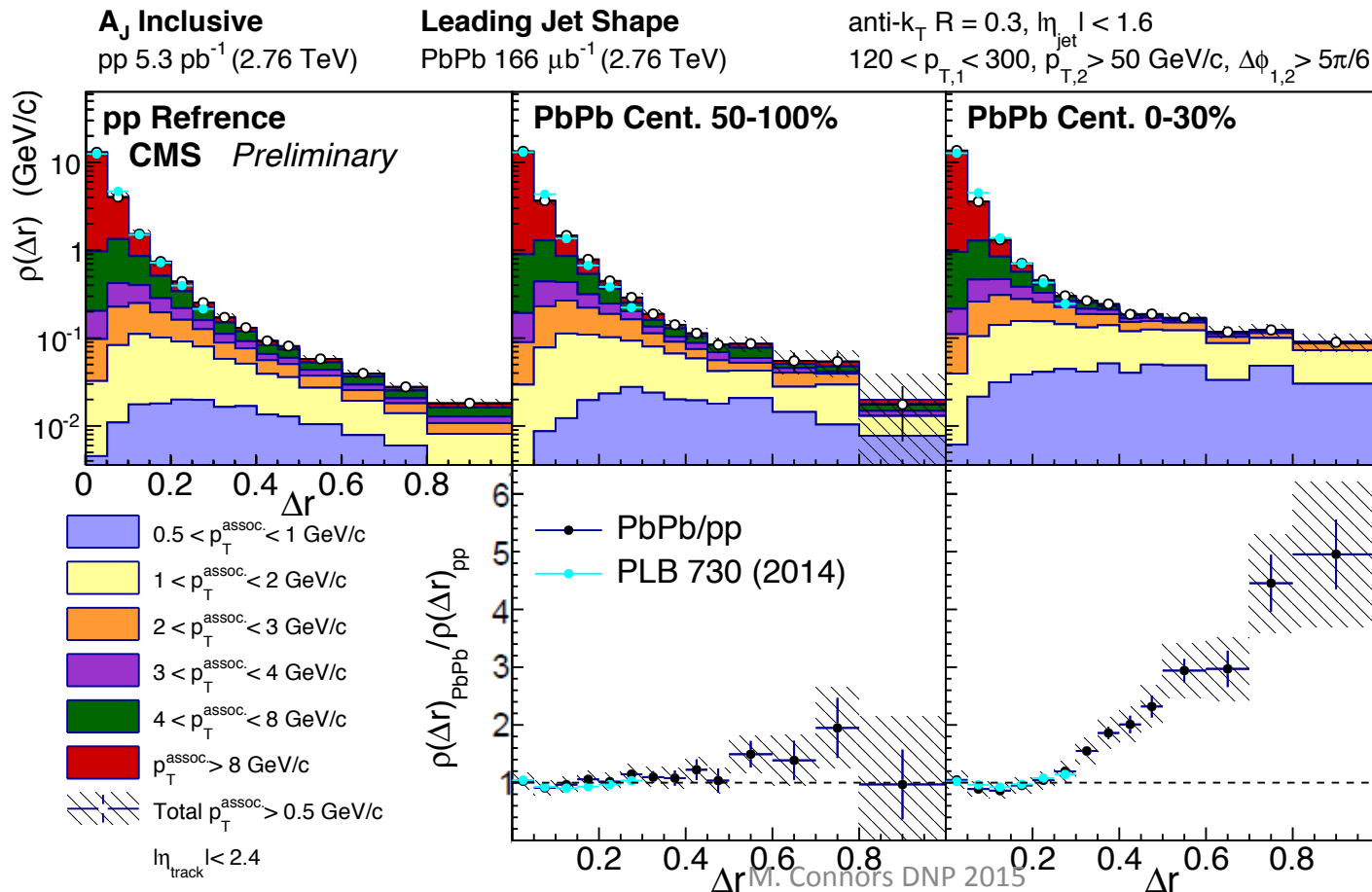

Where does the energy go? RHIC

Jet-hadron Correlations

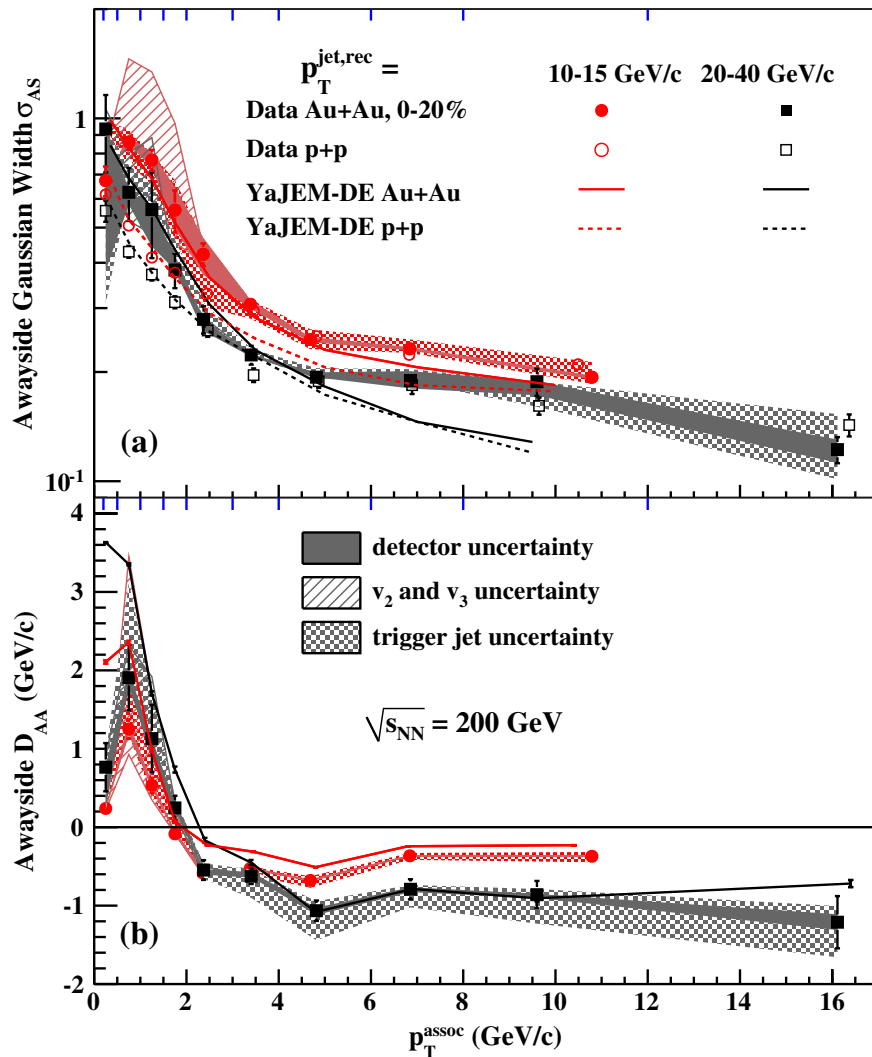

- Surface bias jet with high p_T constituent & study away-side jet
- Enhanced low momentum particle production
- Width appears broader but large uncertainties

$p_T^{\text{jet,rec}}$ (GeV/c)	ΣD_{AA} (GeV/c)	Detector uncertainty (GeV/c)	v_2 and v_3 uncertainty (GeV/c)	Jet energy scale uncertainty (GeV/c)
10-15	-0.6 ± 0.2	+0.2 -0.2	+3.7 -0.5	+2.3 -0.0

LHC vs RHIC Jets

- Similar level of suppression
- Enhancement of low momentum particles at broader angles at LHC
- RHIC more sensitive to surface bias effects

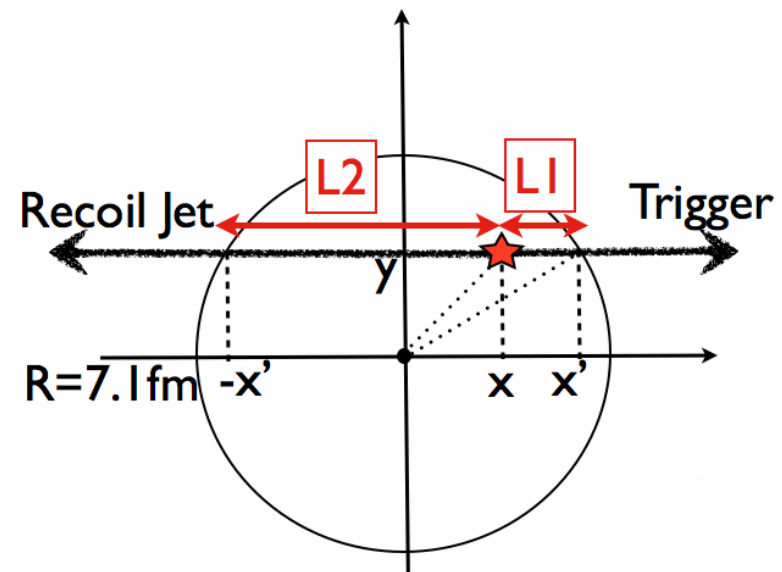
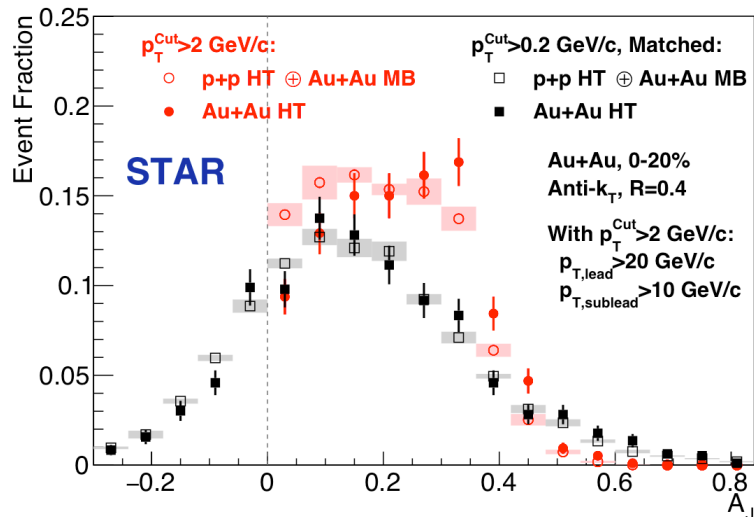

Physics Conclusions

What is the effect of small systems on jets?

-Strong suppression is not a CNM effect

Where does the lost energy go?

-Low momentum particles at large angles

Does the pathlength effect quenching?

-Yes! Suppression depends on in- or out-of-plane

-Beware of surface bias effects

Is the fragmentation pp like?

-No: Modified fragmentation functions measured

-Yes: Jet substructure is pp like

-Yes: Jet composition is the pp like

What happens to dijet pairs?

-Energy imbalance due to different path lengths

How does temperature effect quenching?

-Fractional Eloss depends on energy density

-LHC-RHIC complementarity constrains models

Are jets effected by the medium?

-Yes, jets lose energy and appear to be quenched by the medium

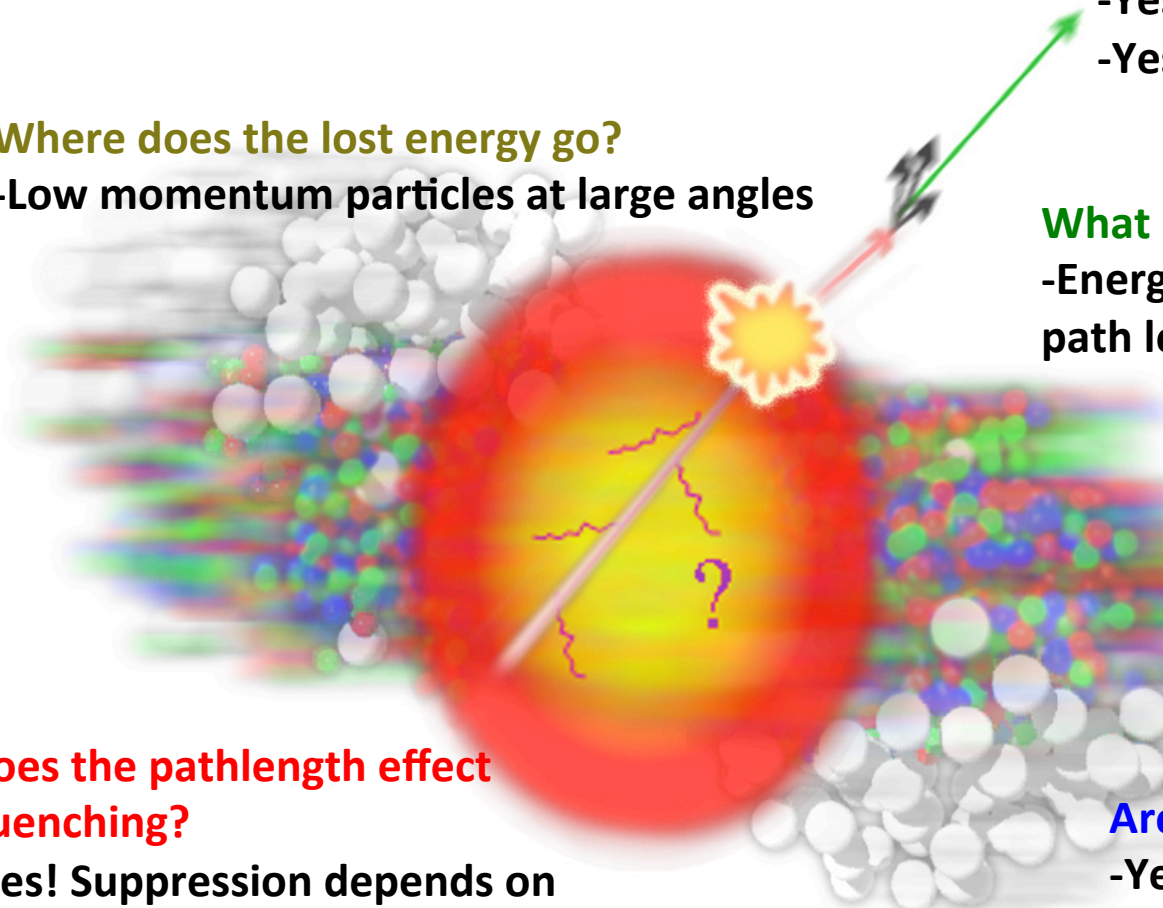

LHC and RHIC Jet Complementarity

- LHC has more jets
- RHIC jets are more influenced by the QGP
- Different temperatures of the QGP

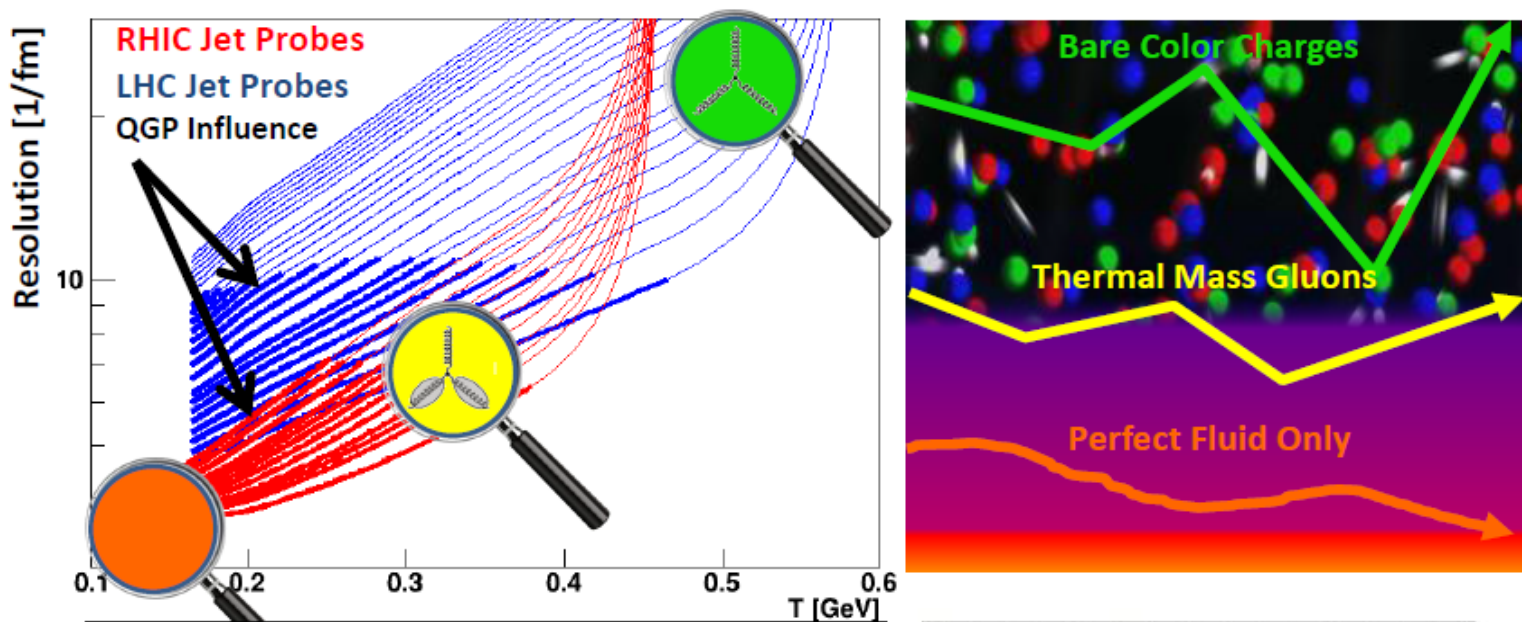

LHC and RHIC Jet Complimentarity

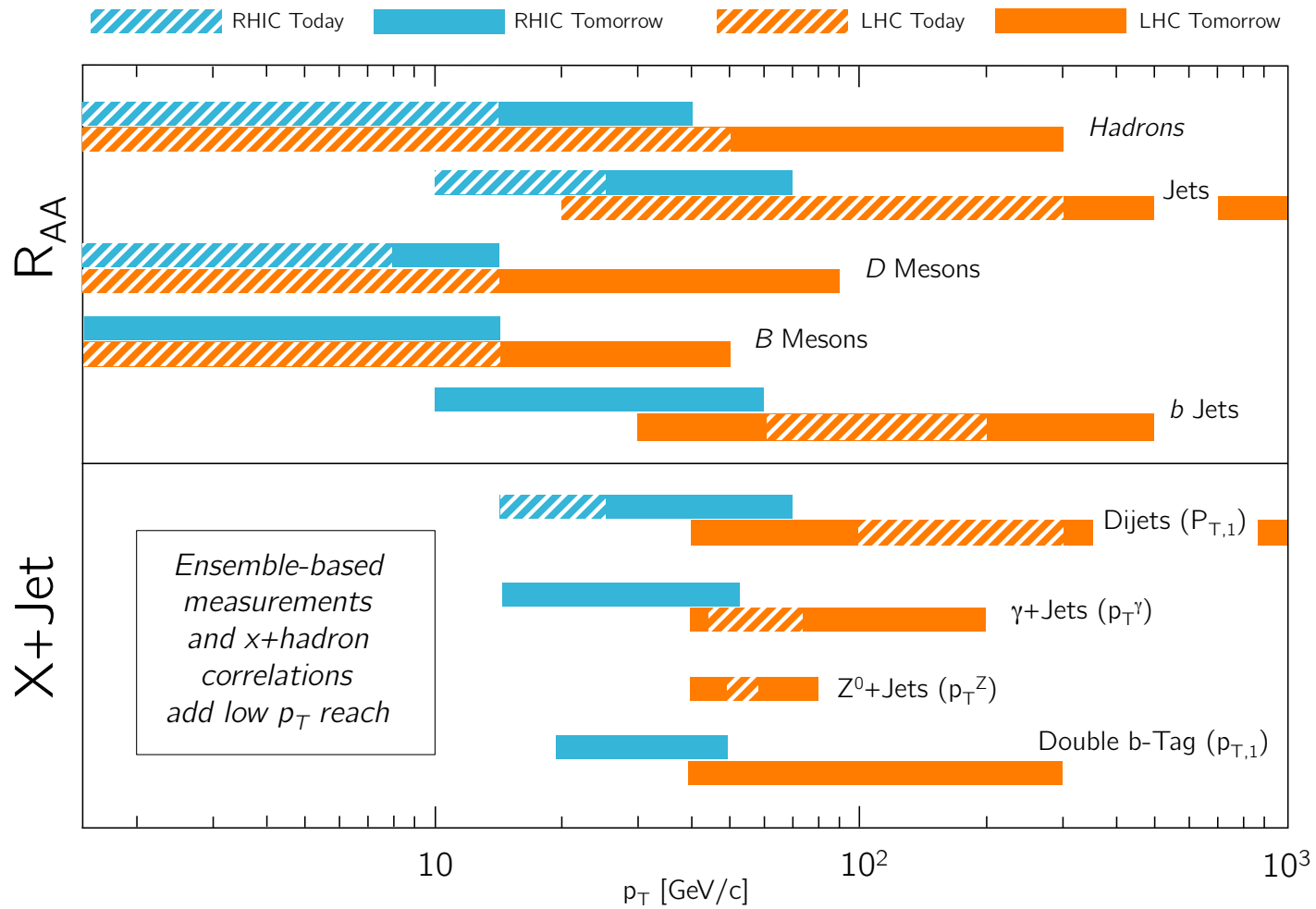

- From September 2014 Town Hall meeting

Discovery to Precision

- I believe there are still surprises to be discovered but perhaps in the details
- Currently embarking on an era of photon tagged jets, jet substructure and precise heavy flavor measurements

photon p_T : 79.6-125 GeV
jet p_T : 63.1-144 GeV

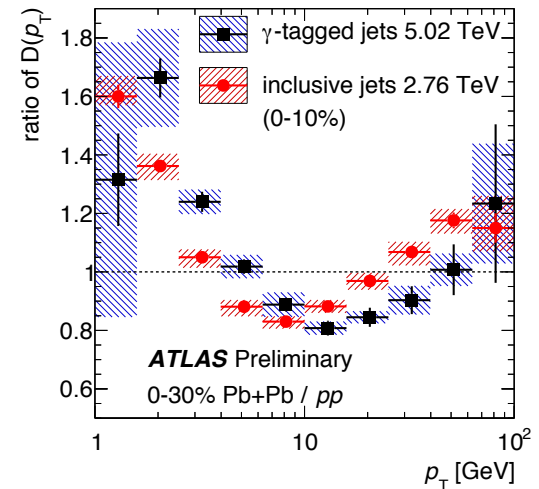

ALICE: mass from charged particles

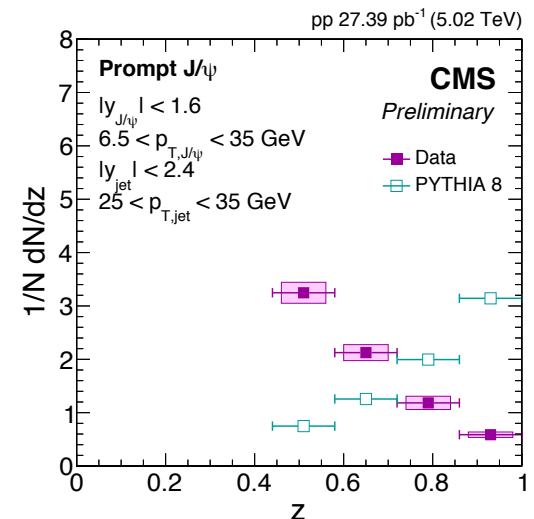
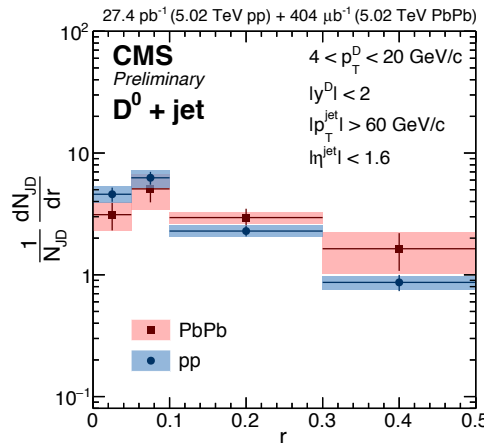
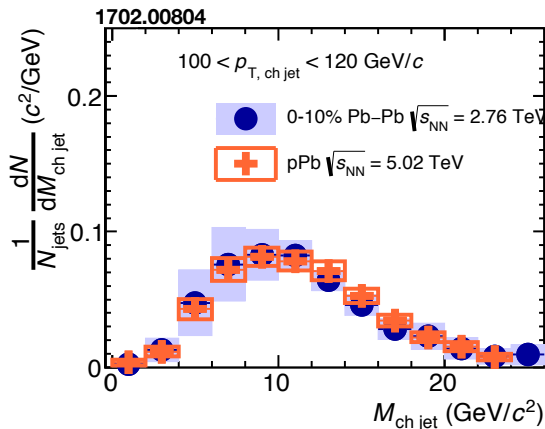

sPHENIX

- Upgrade to PHENIX
- Plan to start taking data in 2023

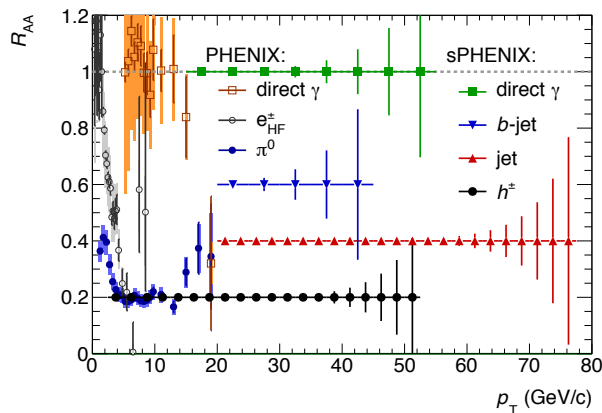

Schematic Design

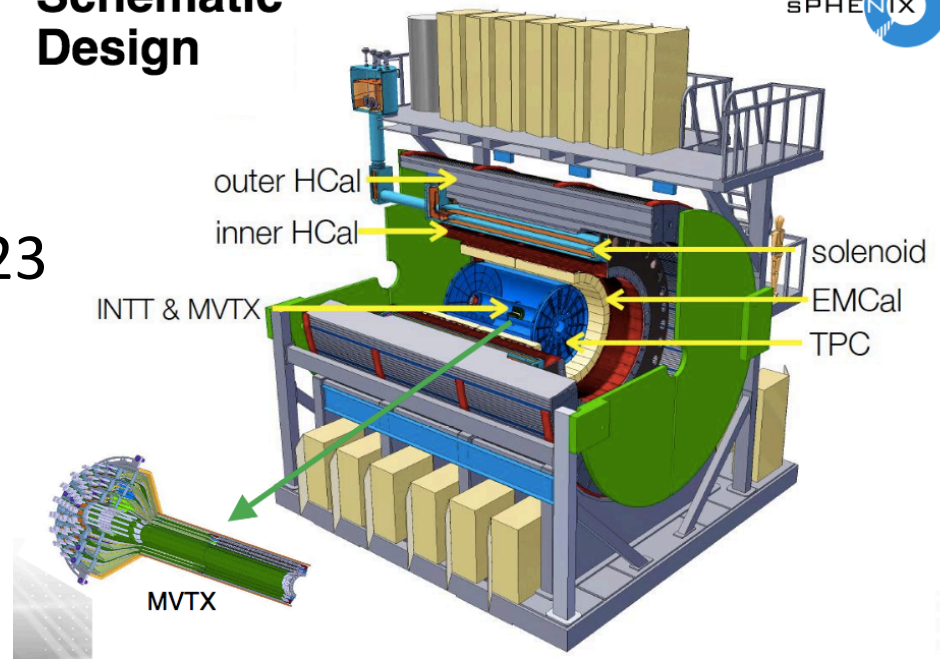

Quarkonium spectroscopy
vary size of probe

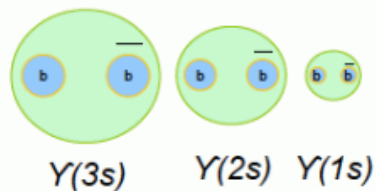

Jet structure
vary momentum/angular scale of probe

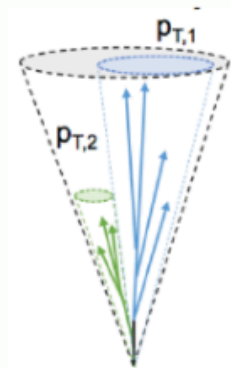

Parton energy loss
vary mass/momentum of probe

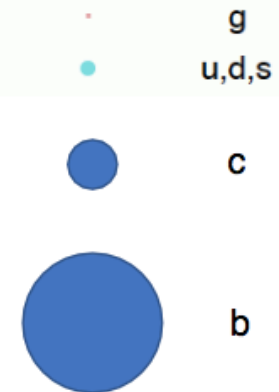

Over Simplification of Quarkonia Melting

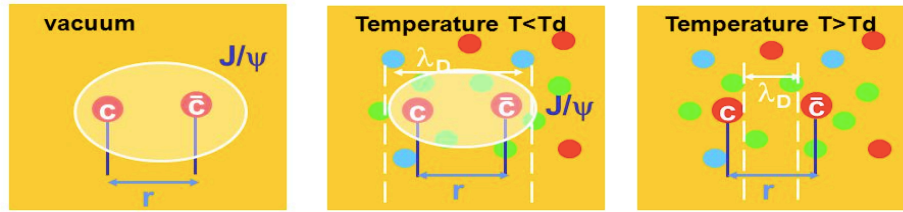

$$r_{q\bar{q}} \sim 1/E_{binding} > r_D \sim 1/T$$

- **“Thermometer”**: different states dissociate at different temperatures \rightarrow *sequential suppression*

	J/ψ	$\psi(2S)$	$\Upsilon(1S)$	$\Upsilon(2S)$	$\Upsilon(3S)$
E_b (MeV)	~ 640	~ 60	~ 1100	~ 500	~ 200

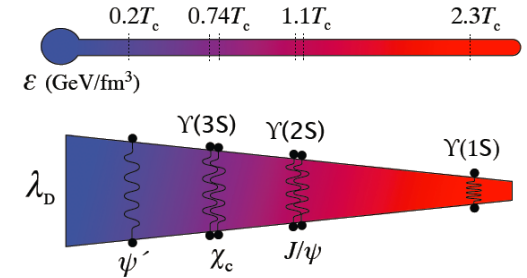

05/18/2018

Rongrong Ma (BNL), QM2018

5

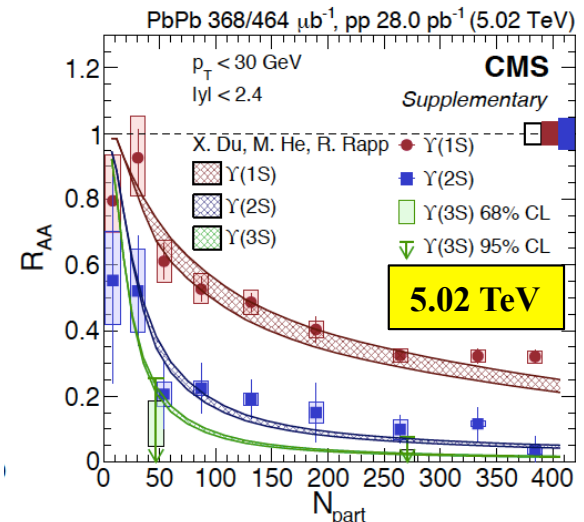
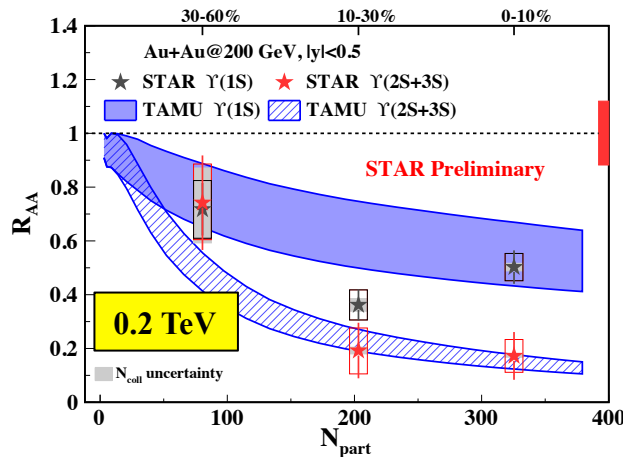

46

Theory Comparisons

- Amount of experimental measurements with the dawn of the LHC is impressive and continually growing (Xe+Xe)
- Models need to describe all stages of the collision to fully explain the increasingly precise data
- Theory Collaborations

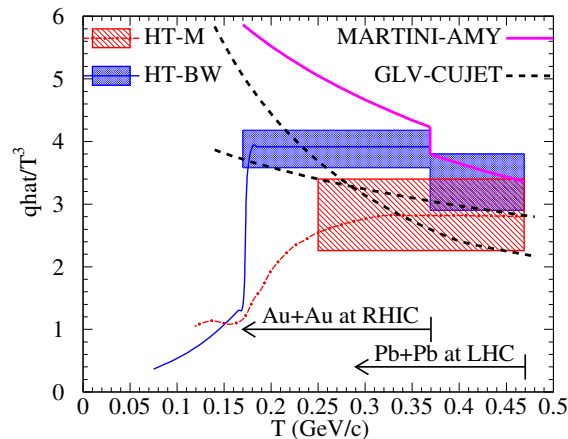

<http://jet.lbl.gov/documents-1/report-on-status-of-qhat>

JETSCAPE

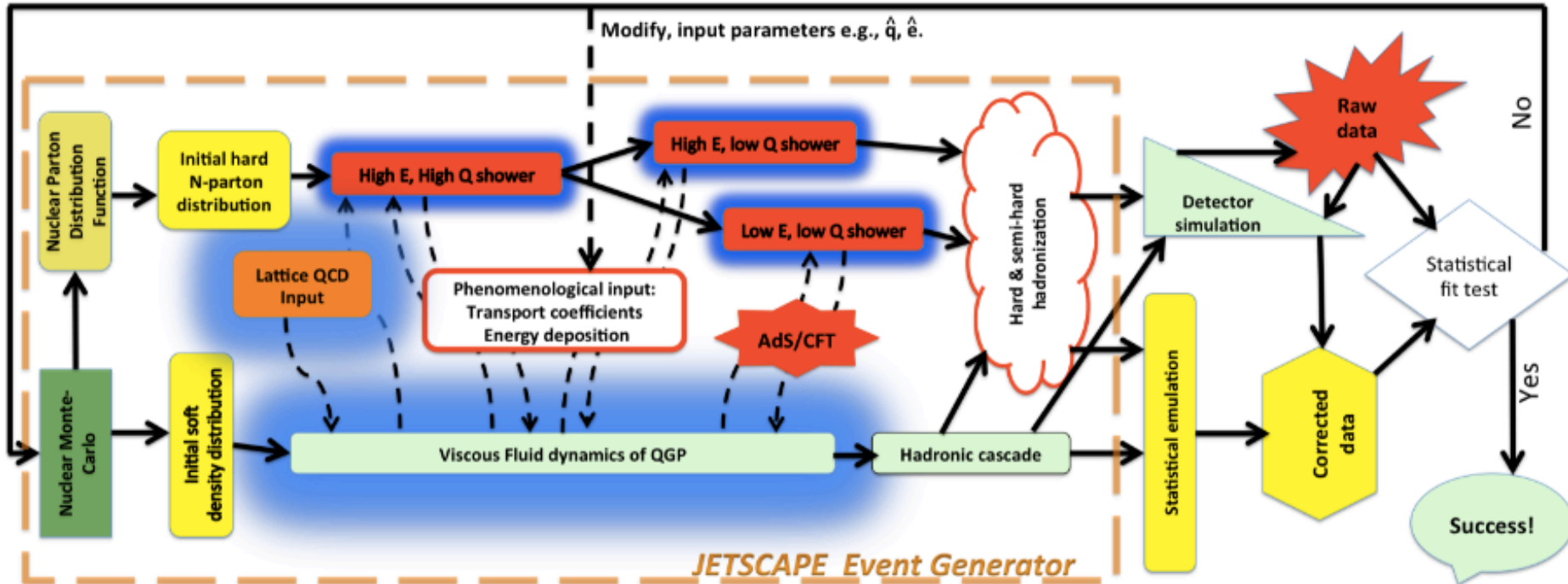
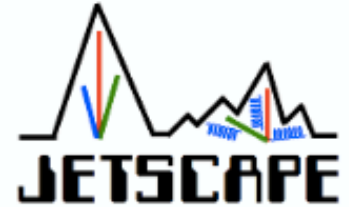

Put 'em together and what have you got

Take home messages

- Jets are a useful probes of the QGP
- Reconstructed Jets are a robust observable
- We have learned a lot about jets in the QGP without reconstructing jets
- Reconstructed jets allow us to study modifications to the substructure of the jets
- Photon tagged jets are a golden probe for studying energy loss in the QGP
- RHIC and LHC are complimentary facilities
 - Run 2 underway at LHC
 - sPHENIX starts data taking in 2023
 - Theory collaborations bridge gap in apples to apples comparisons

Tool Box

- JETSCAPE

www.github.com/JETSCAPE/JETSCAPE

- Jet finding algorithms: FastJet

- ▶ M.Cacciari, G.Salam, G. Soyez (see <http://fastjet.fr/>)

- Unfolding: RooUnfold

- Review of Jet Measurements:

- Connors et al, arxiv:1705.01974

