

Accreting White Dwarfs

Donor star of pure He

White Dwarf of Carbon/Oxygen
Or Oxygen / Neon

Piro '05

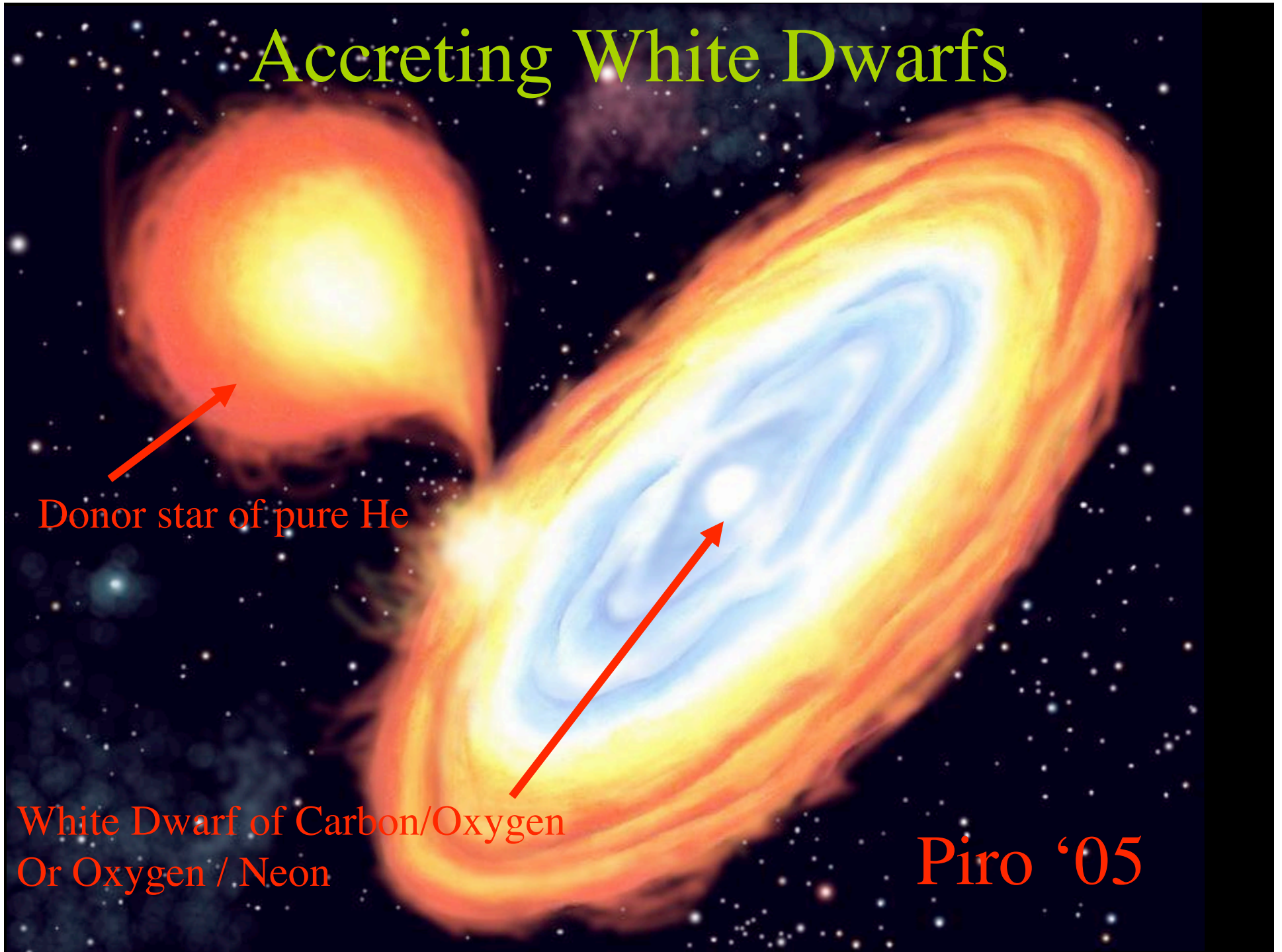

Path to Dynamical Helium Shells

The radial expansion of the convective region allows the pressure at the base to drop. For low shell masses, this quenches burning. For a massive shell, however, the heating timescale set by nuclear reactions:

$$t_{\text{nuc}} = \frac{C_P T}{\epsilon_{\text{nuc}}}$$

will become less than the dynamical time,

$$t_{\text{dyn}} = \frac{H}{c_s} = \frac{P}{\rho g c_s}$$

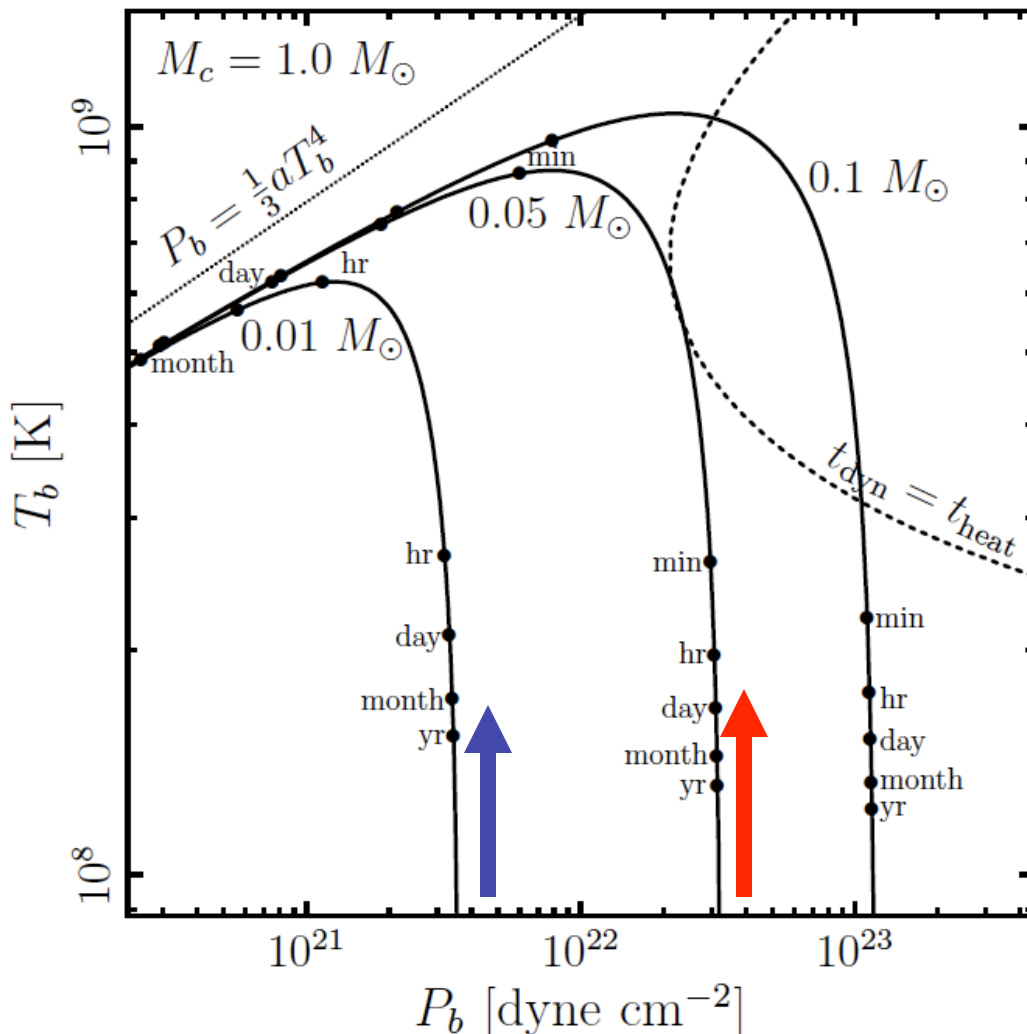

So that the heat cannot escape during the burn, potentially triggering a detonation of the helium shell. This condition sets a minimum shell mass.

Nucleosynthesis

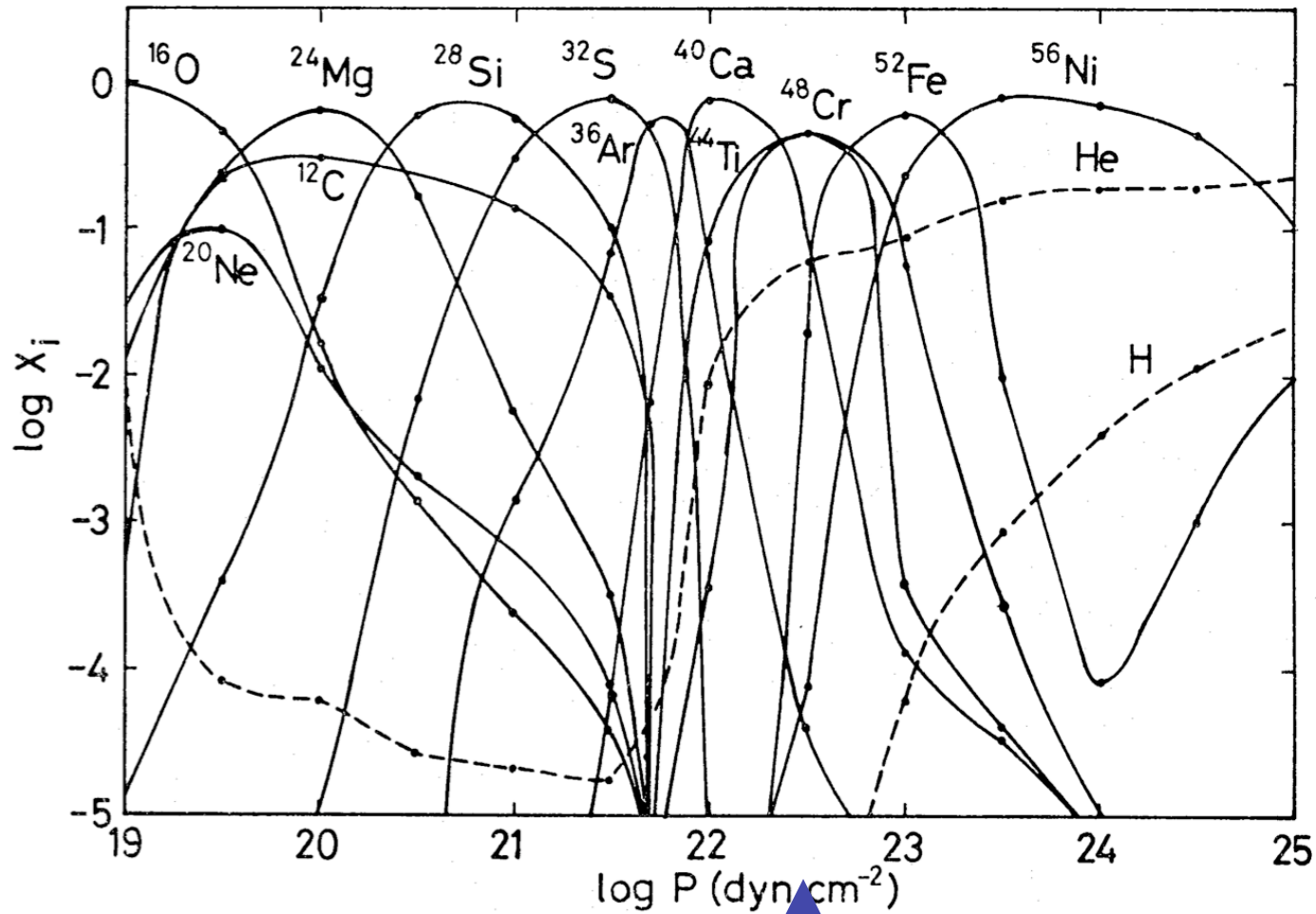

Sugimoto et al (1983)

Radioactive Decay Chains



Sample Detonation

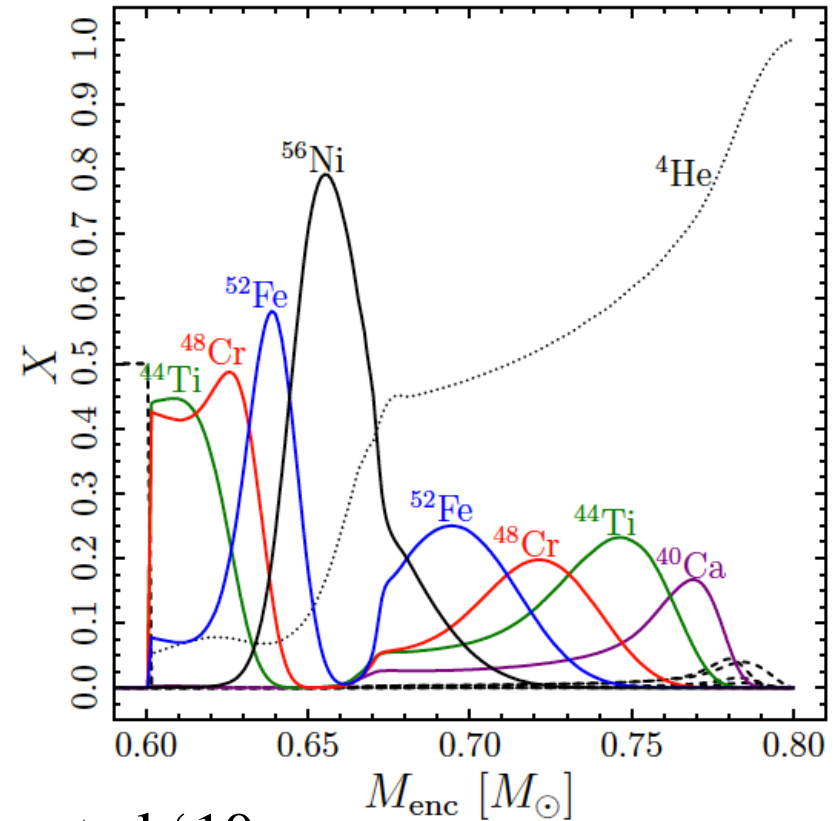
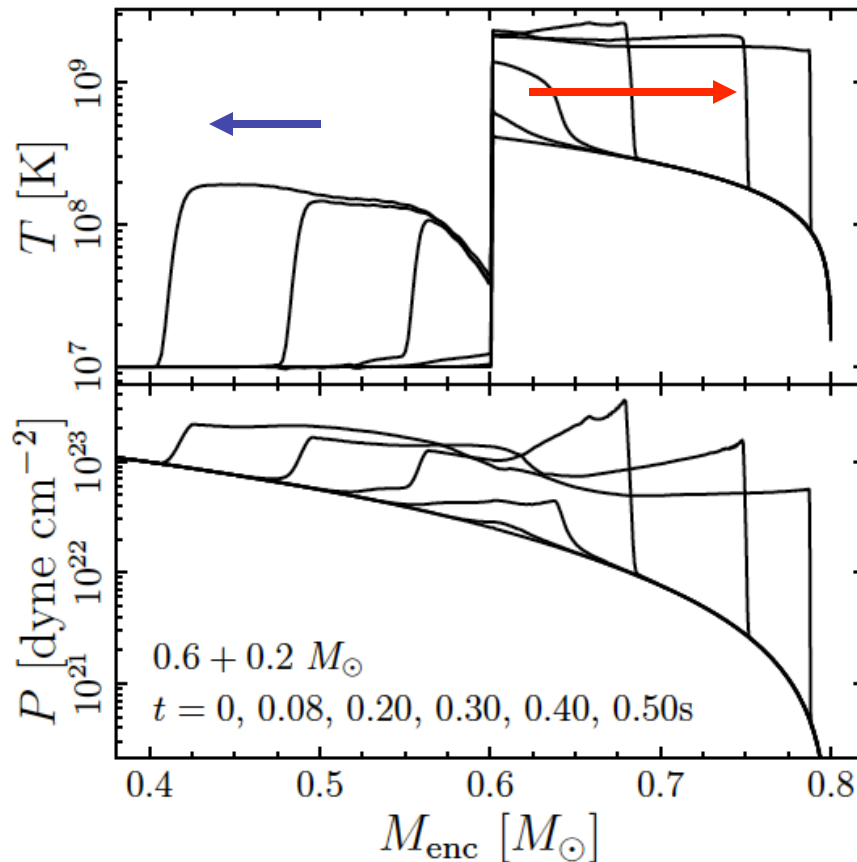

Shen et al '10

Shock (blue arrow) goes into the C/O and a He detonation (red arrow) moves outward. The shocked C/O under the layer is not ignited. Underlying WD remains unless converging shocks detonate it (see Livne & Glasner; Fink, Roepke & Hillebrandt '07)

Ia Supernovae*

L. B., Shen, Weinberg & Nelemans '07
Shen et al 2010

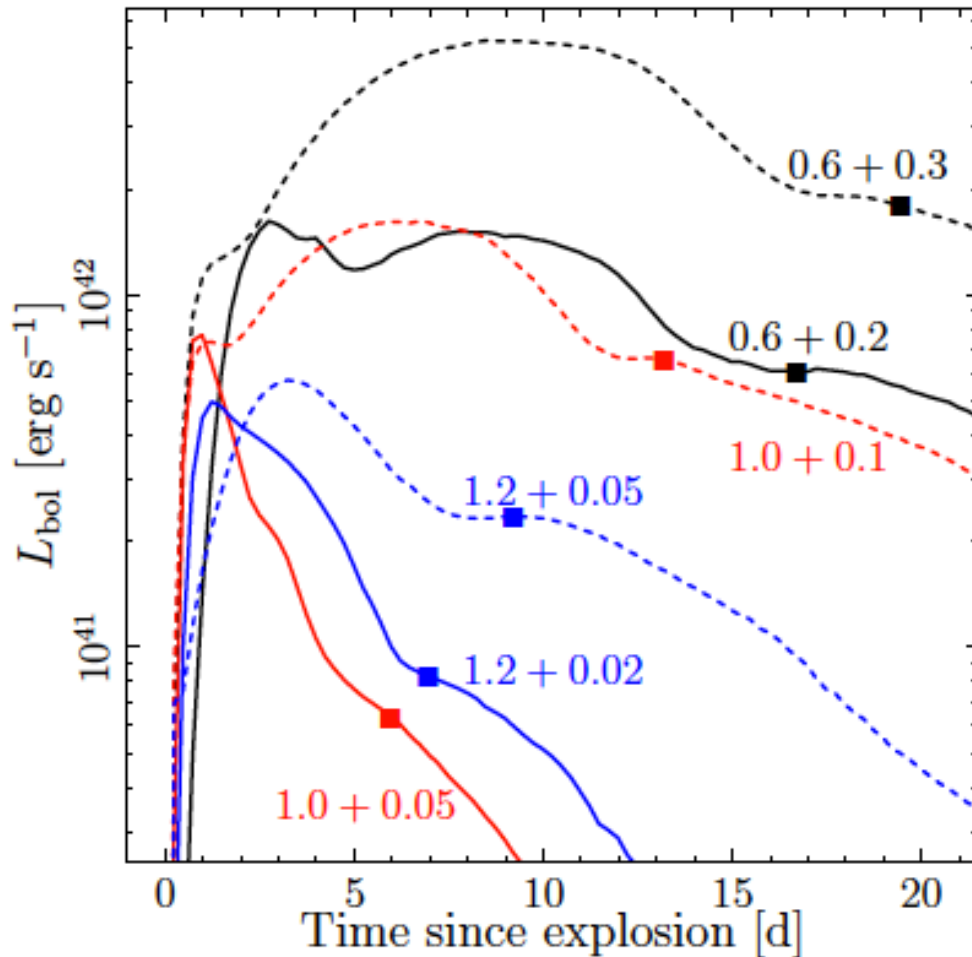

- The $0.02\text{-}0.1M_{\odot}$ ignition masses only burns the helium, which leaves the WD at $10,000$ km/sec, leading to brief events

$$\tau_m = \left(\frac{\kappa M_e}{7c\nu} \right)^{1/2} \approx 3 - 5 \text{ d}$$

- The radioactive decays of the freshly synthesized ^{48}Cr (1.3 d), ^{52}Fe (0.5 d) and ^{56}Ni (8.8 d) will provide power on this short timescale!!

1

*Thanks to Chris Stubbs for the name

Faint and Fast Events!!!

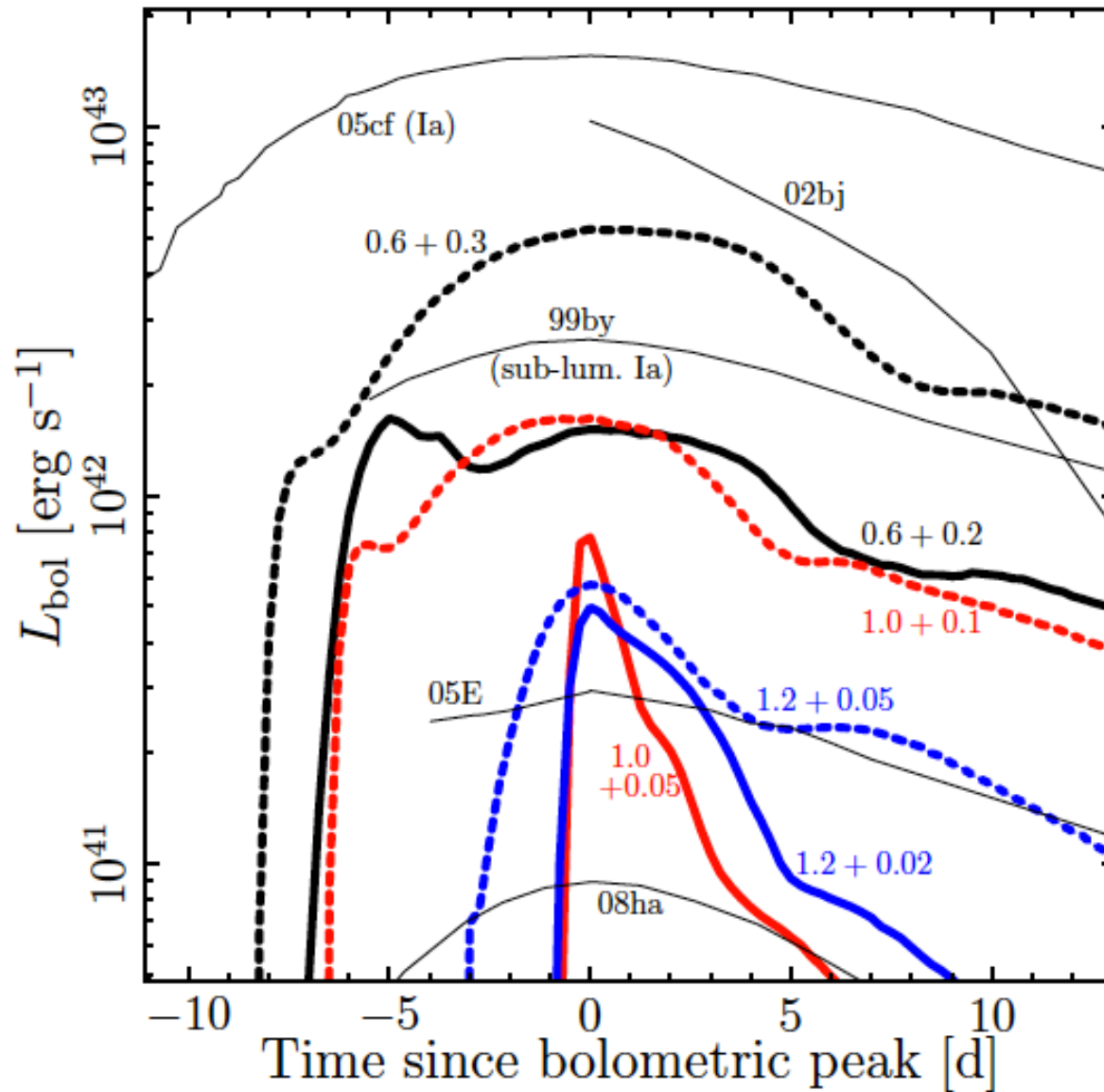

2002bj: Poznanski et al. '09

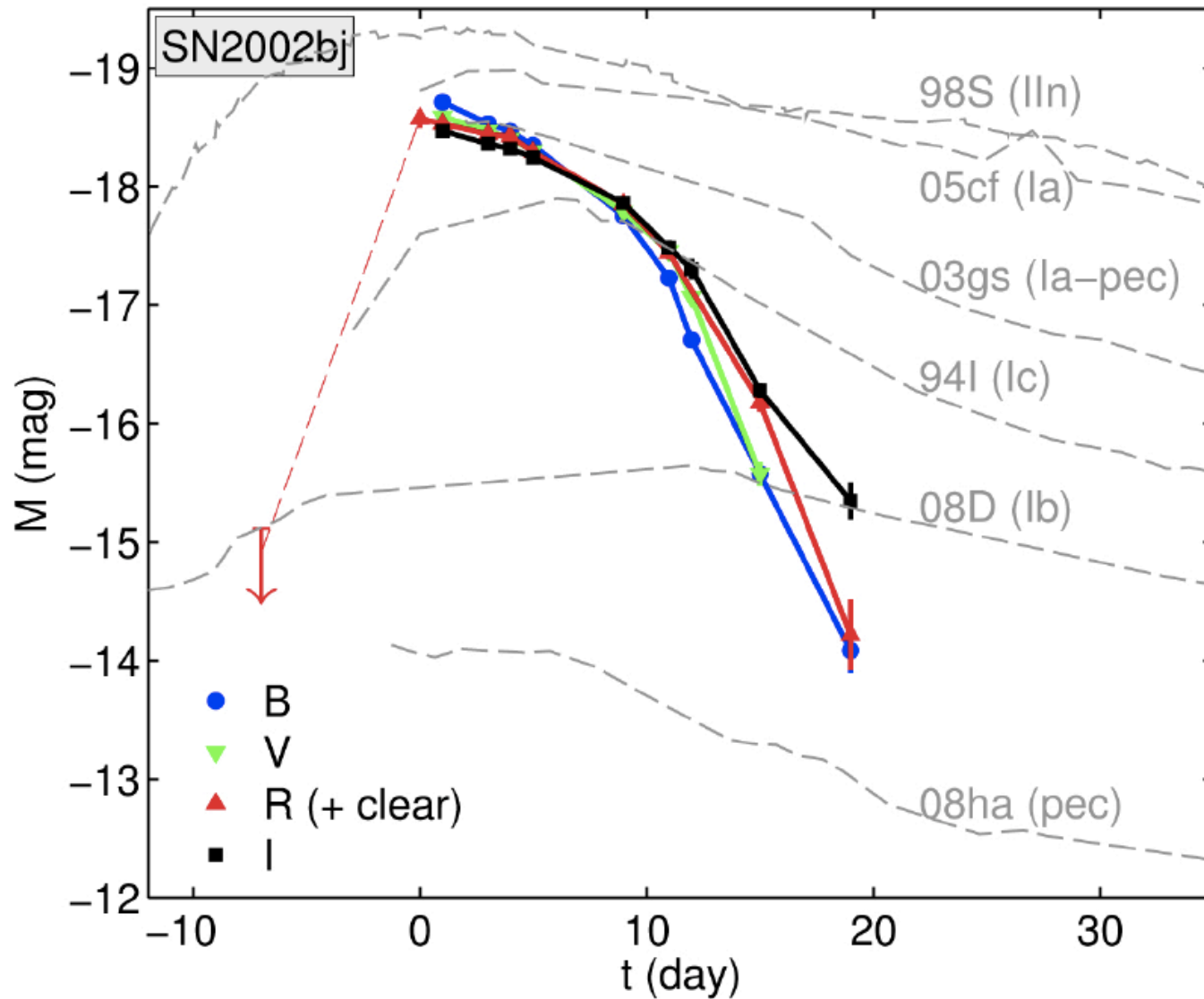

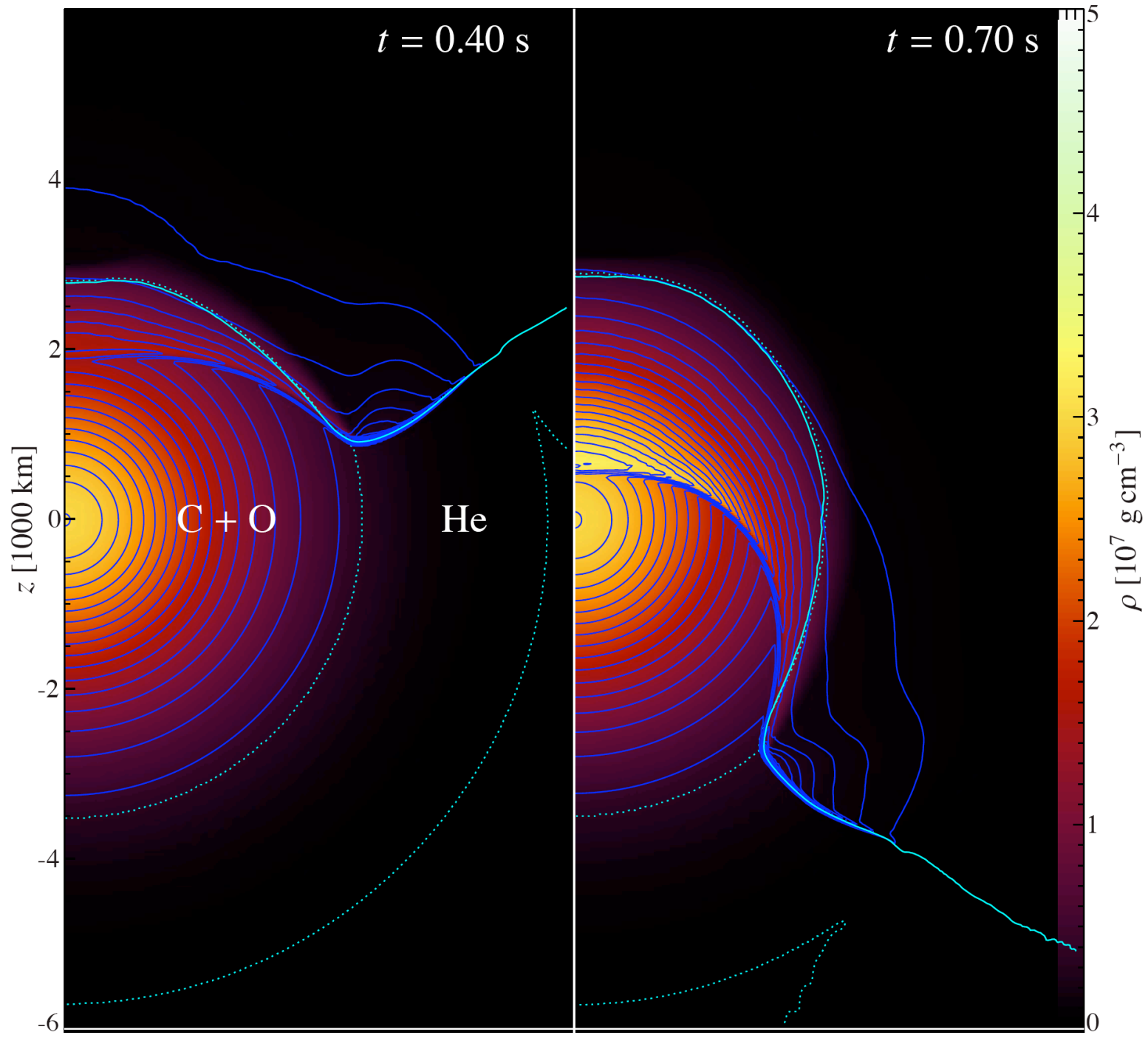

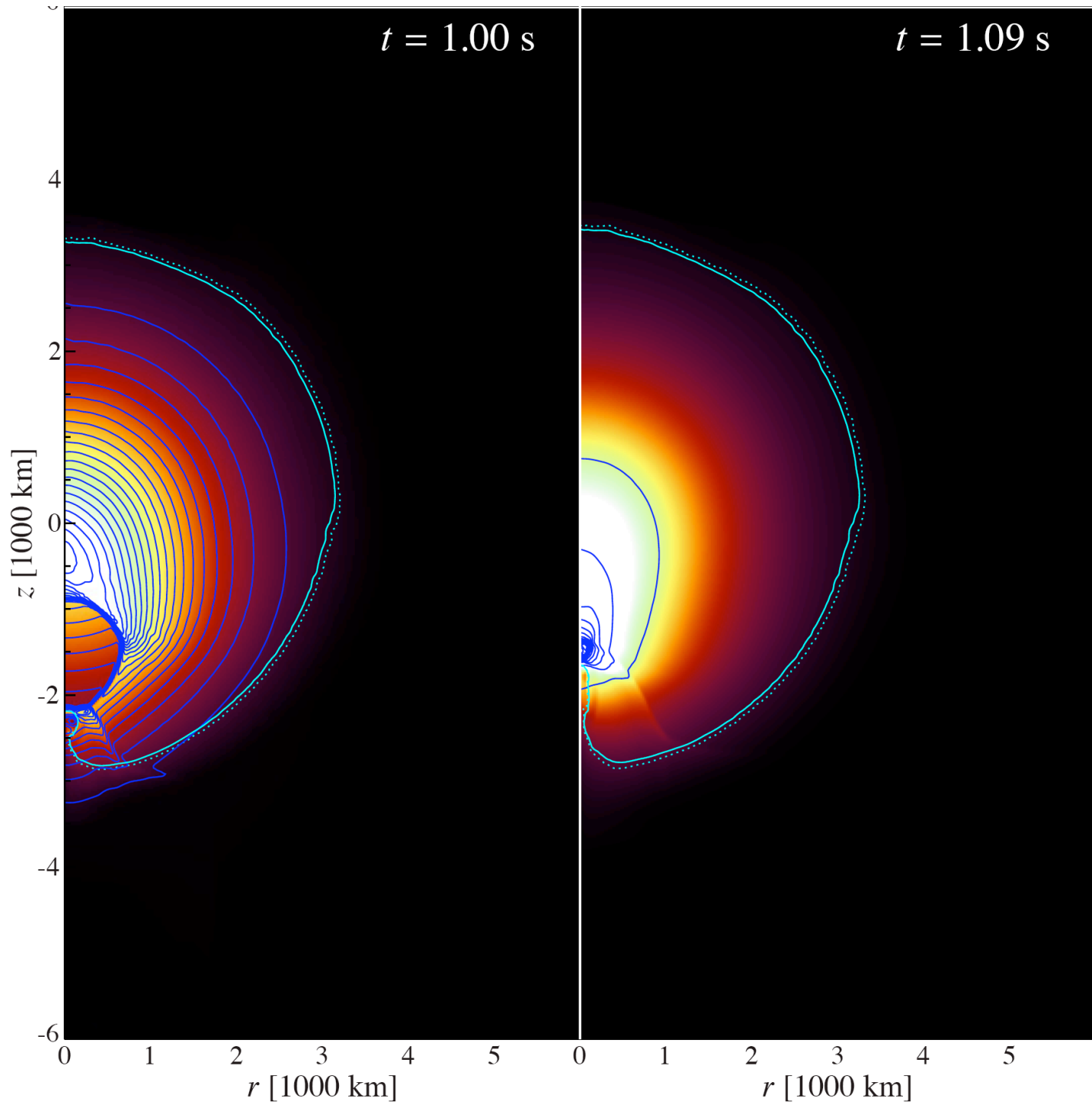

Back to Core Collapse Events
from stars > 10 times that of the
Sun

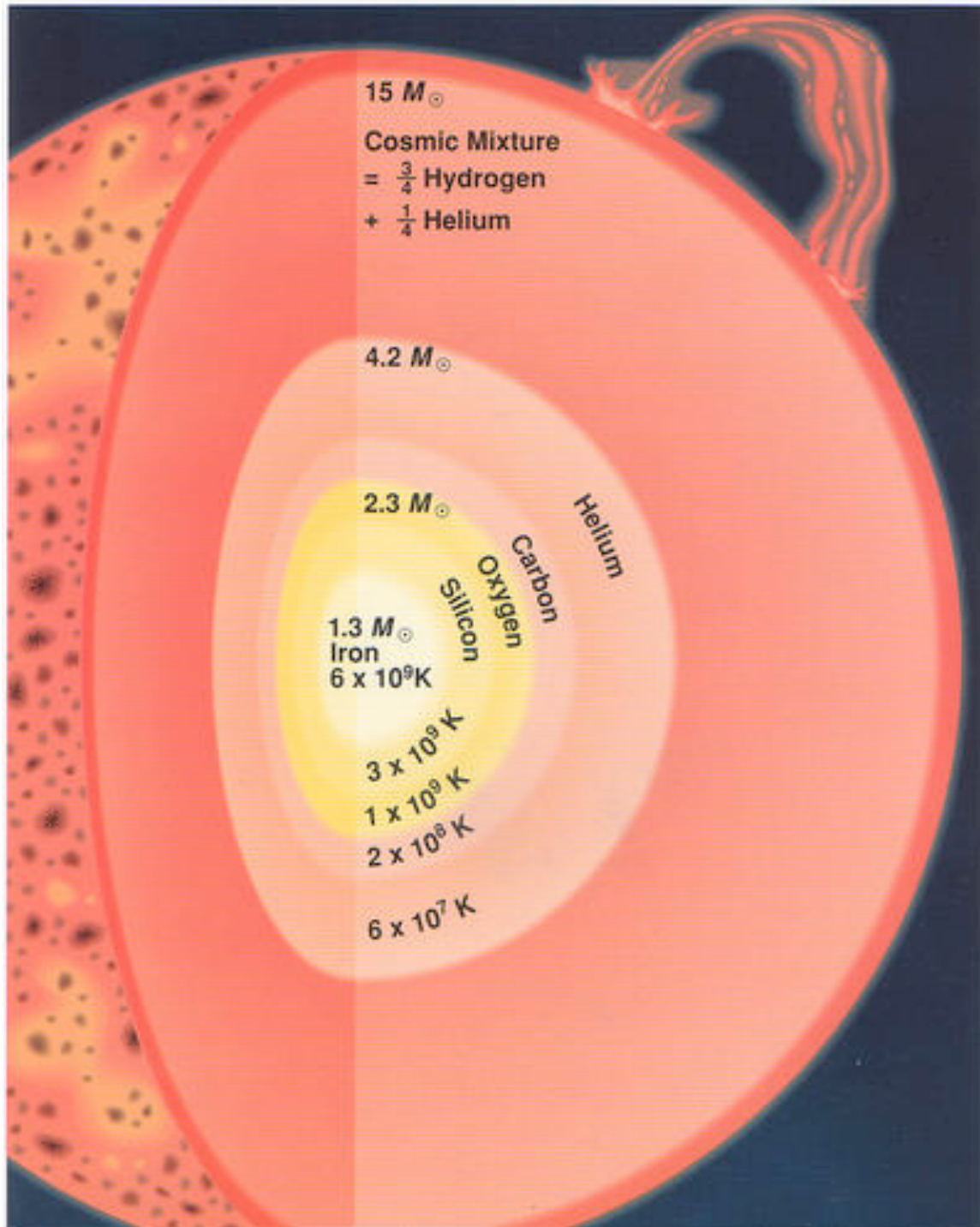

- The shells of matter get ejected, enriching the matter between stars.
- These events make most of the elements like Carbon, Oxygen, Silicon. . . But only some of the Iron.
- The remnant left from the collapse is either a **Neutron Star** or a **Black Hole**.

What's special with 10^{51} ergs?

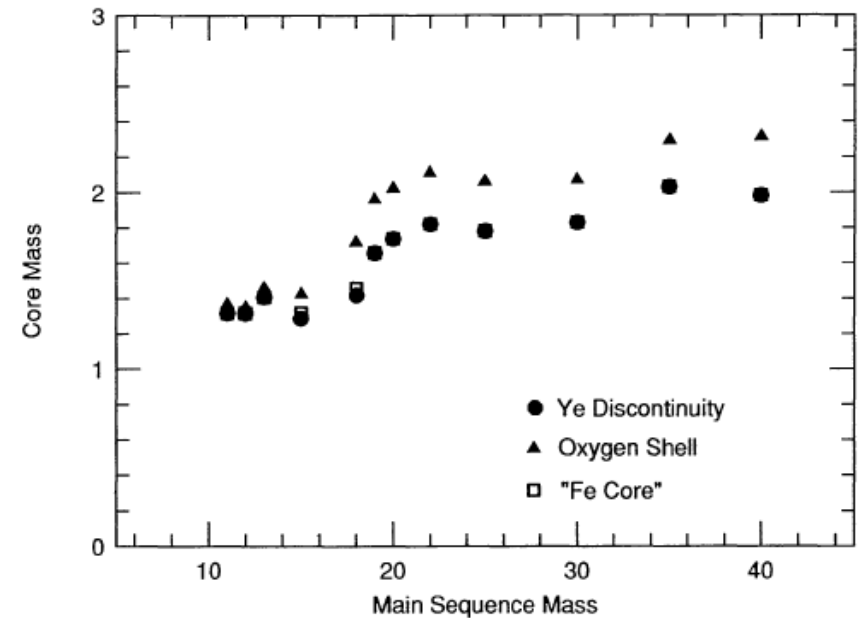
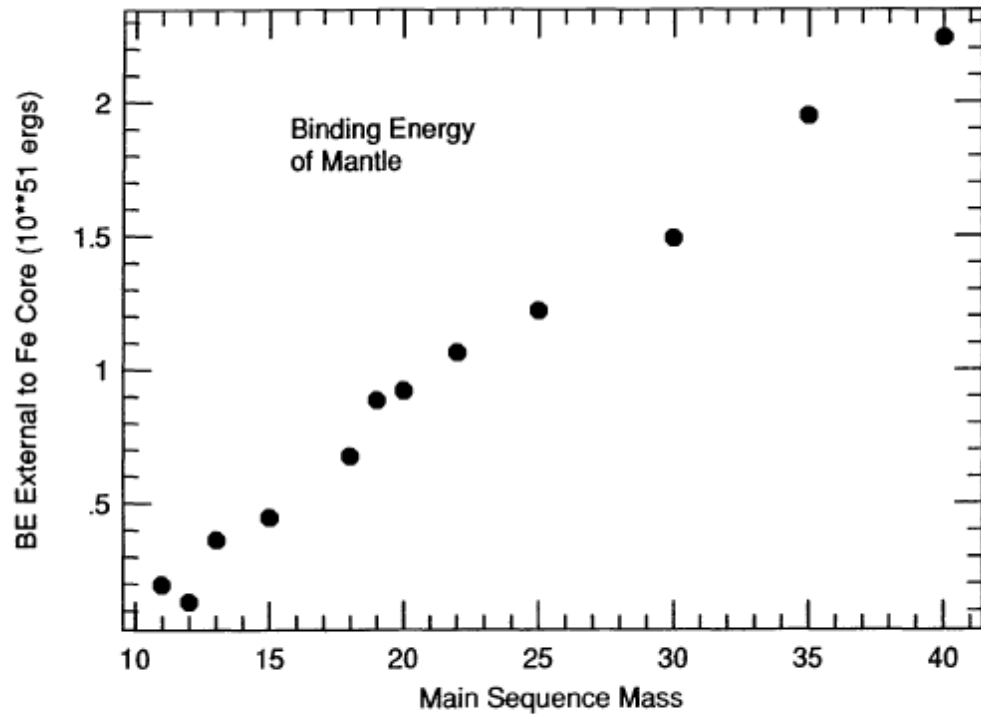
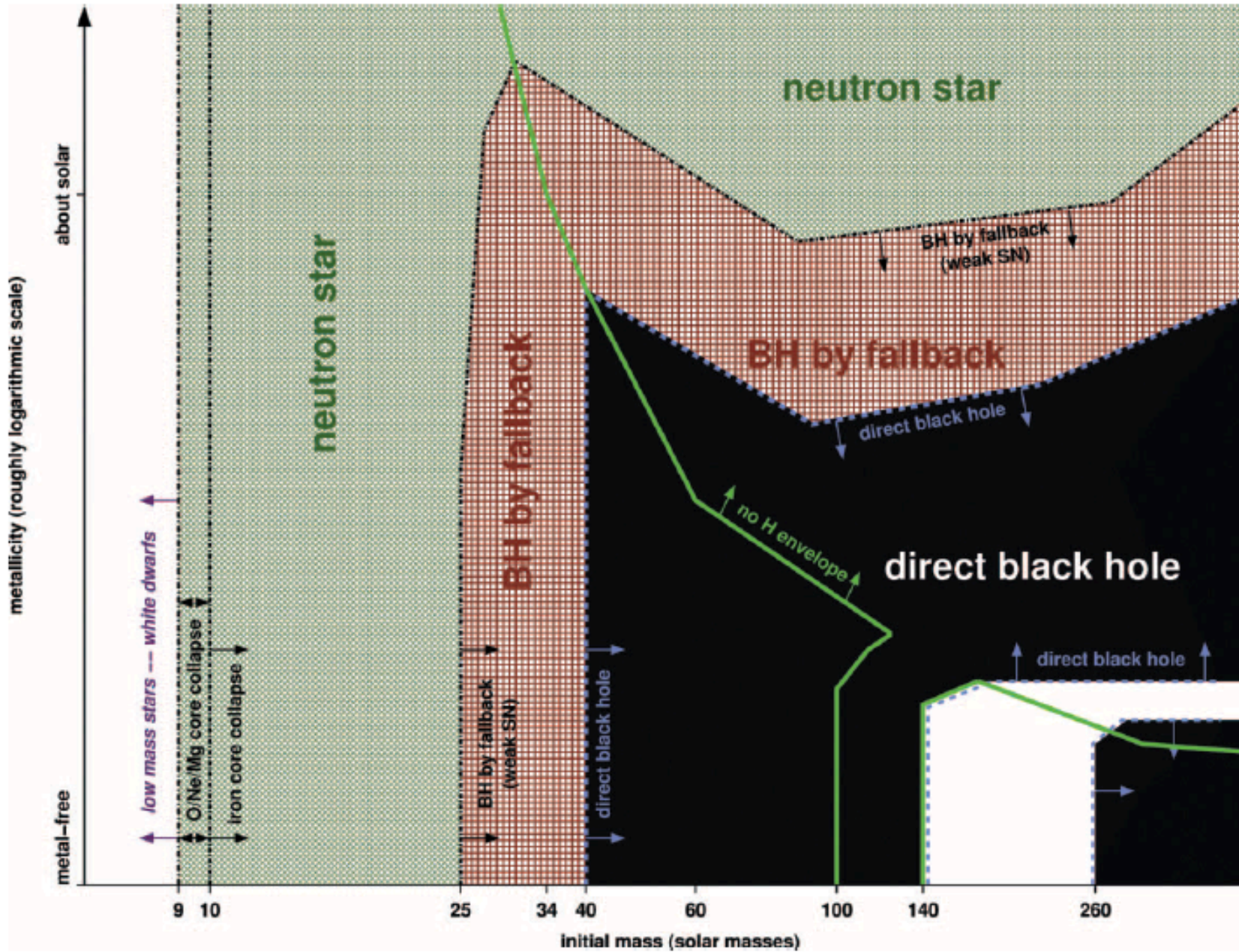

FIG. 5.—Net binding energy external to the piston mass point (Table 3) in stars of solar metallicity.

HW: Neutron Stars. . .

- Calculate the radius of a one solar mass object with a density of 1 baryon/fm^3
- What's the gravitational binding energy of such an object?

HEGER ET AL.



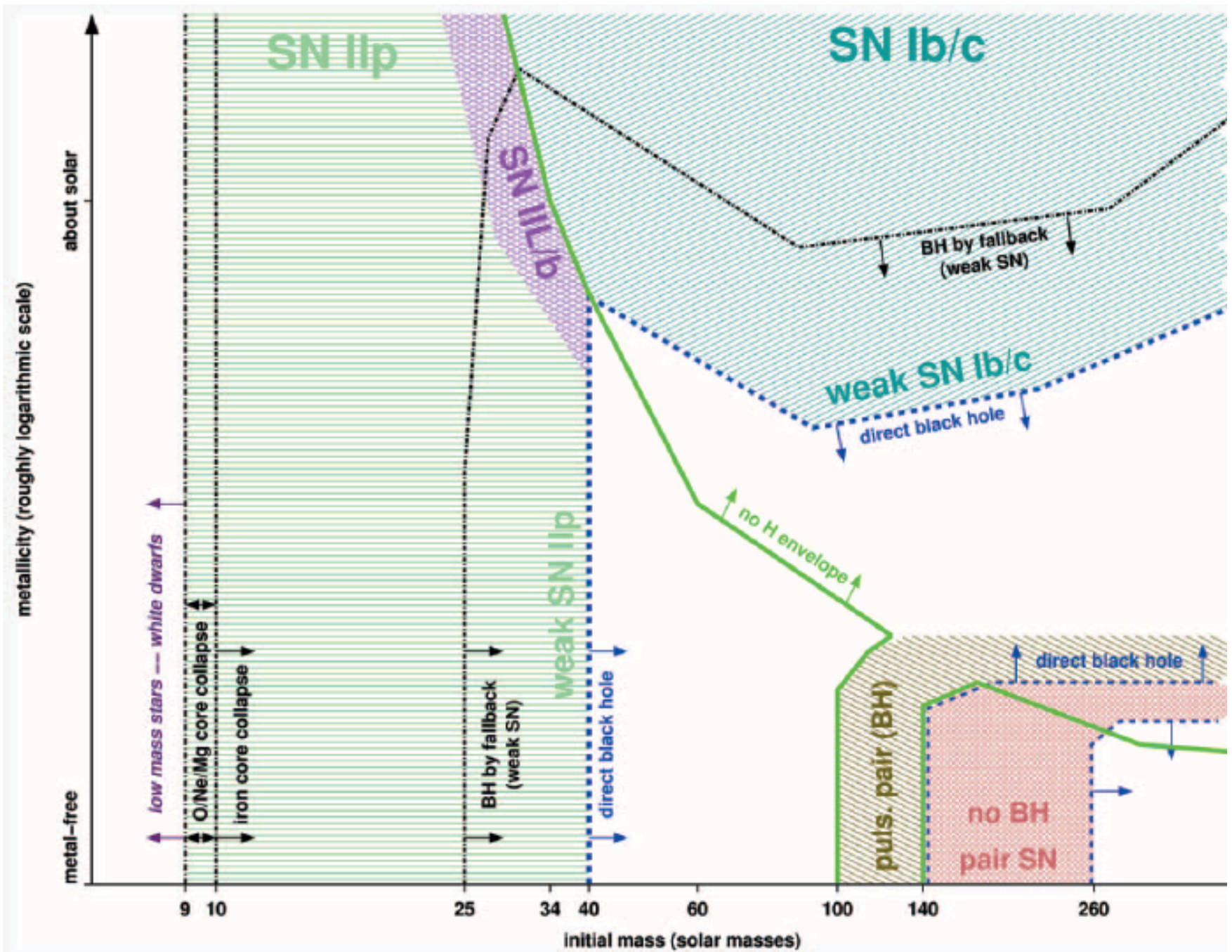

Observed Fractions of Core-Collapse Supernova Types and Initial Masses of their Single and Binary Progenitor Stars

Nathan Smith^{1*}, Weidong Li¹, Alexei V. Filippenko¹, & Ryan Chornock²

¹ Department of Astronomy, University of California, Berkeley, CA 94720-3411, USA

² Harvard-Smithsonian Center for Astrophysics, 60 Garden St., Cambridge, MA 02138, USA

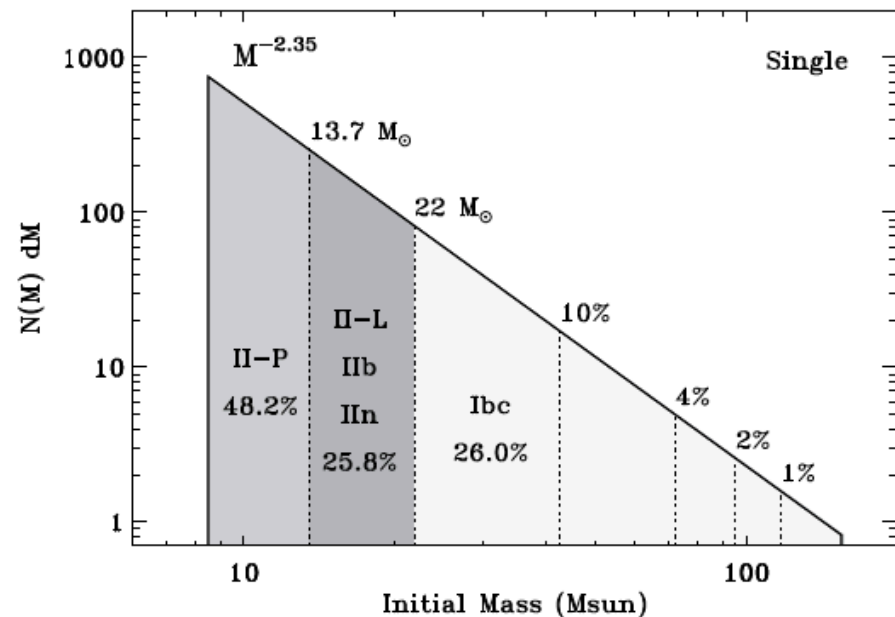
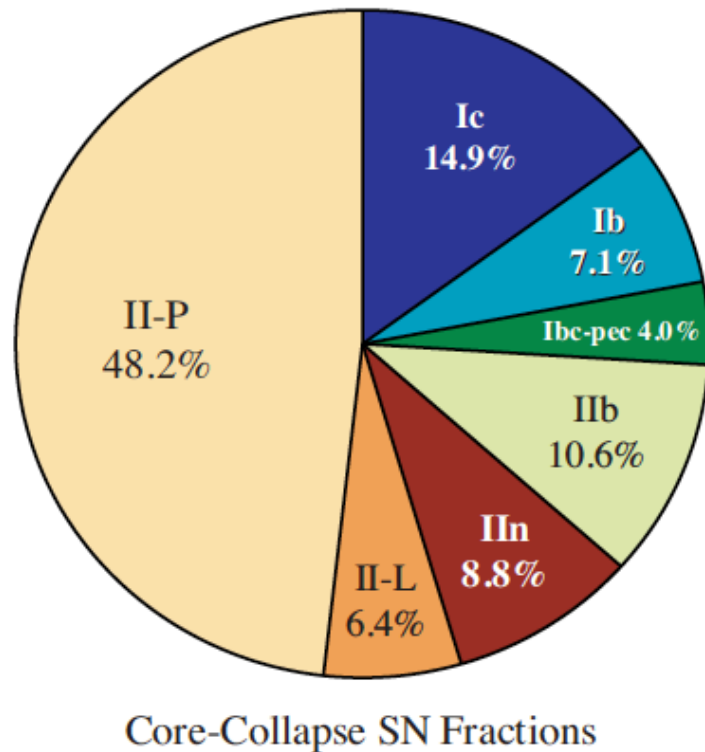

Figure 1. Relative fractions of CCSN types in a volume-limited sample from LOSS. This is slightly different from the fractions quoted in Paper II, in order to better suit the aim of this paper as explained in the text. The main difference is that we exclude SNe in highly inclined galaxies because of extinction effects, and we reorganise the class of SNe Ibc-pec (namely, we moved broad-lined SNe Ic from the “Ibc-pec” category to the “Ic” group).

HW Problem

- Presuming a fixed total energy of the shock, and that all energy is in radiation, what's the Temperature of the shocked volume when the shock is at radius R ?

Blast Waves

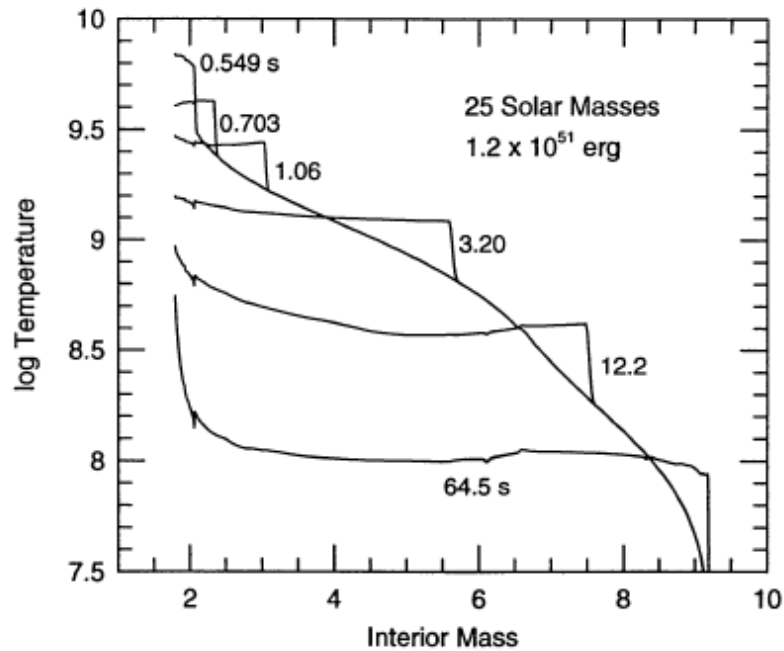

FIG. 8.—Temperature structure as the shock propagates through the mantle and helium core of a $25 M_{\odot}$ solar metallicity model. The kinetic energy of all ejecta at infinity is 1.2×10^{51} ergs. Curves are labeled by the time in seconds at which each is sampled. Note the presence, except near the collapsed core, of large nearly isothermal regions behind the shock.

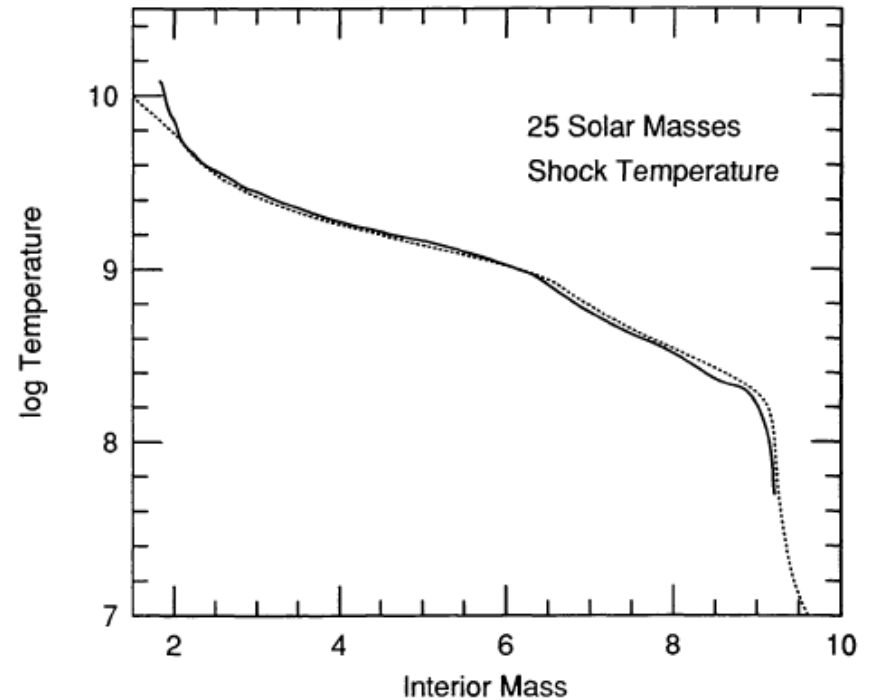
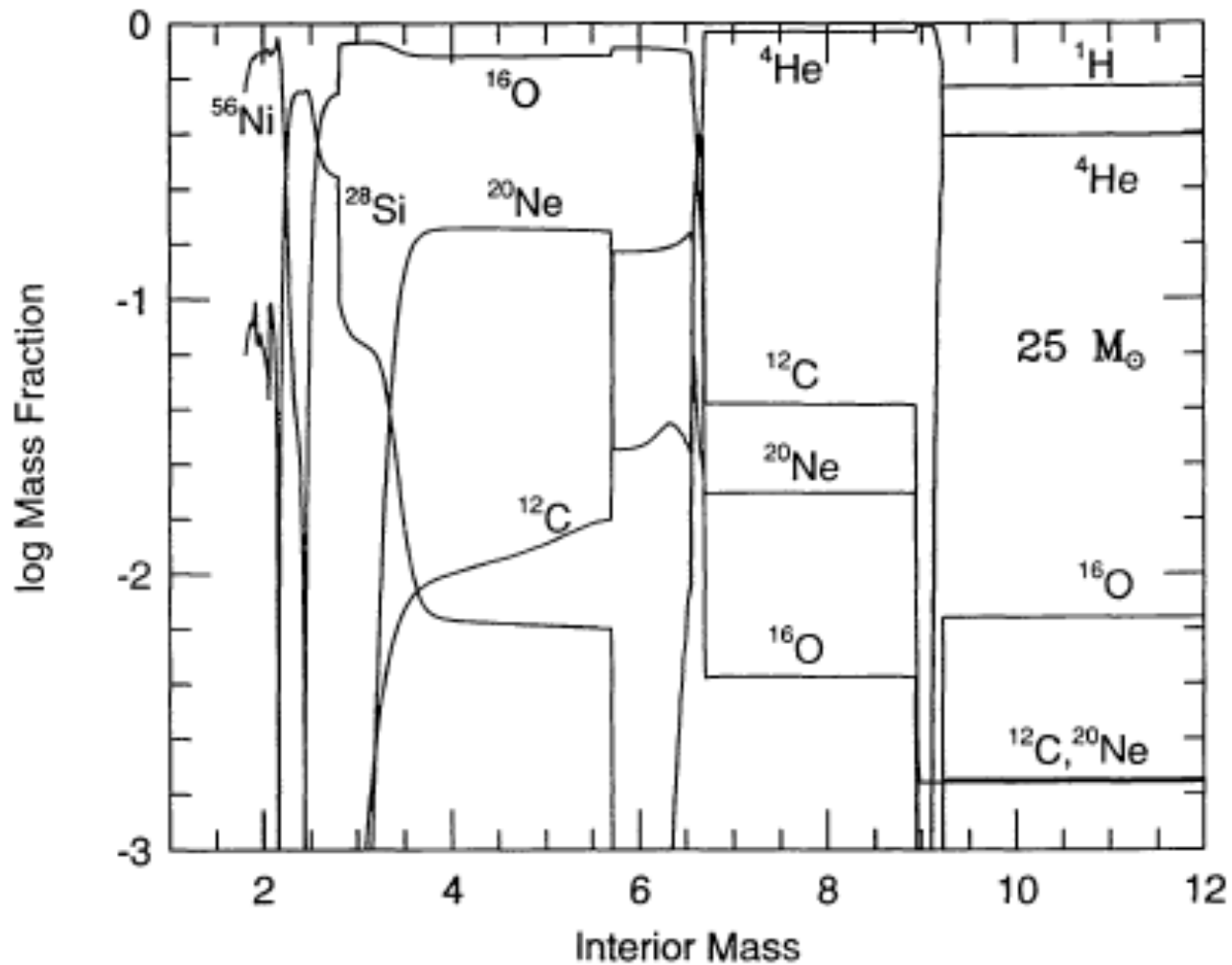

FIG. 9.—Shock temperature as a function of mass (*solid line*) for the same model shown in Fig. 8. The dashed line, which is a very good fit to the solid line except near the collapsed core, is given by $T = (3E_0/4\pi a R_{\text{PSN}}^3)^{1/4}$ where $E_0 = 1.2 \times 10^{51}$ ergs and R_{PSN} is the presupernova radius as a function of enclosed mass.

Woosley and Weaver 1995

Resulting Dominant Abundances



Woosley and Weaver 1995

Luminosity Estimate

- The luminosity is

$$L \sim R^2 \frac{c}{\kappa \rho} \frac{d}{dr} a T^4 \sim \frac{R^3 E_{\text{rad}}}{t_{\text{diff}}}$$

- During the adiabatic phase, T goes like 1/R, giving

$$L \sim \frac{R_o^4 a c T_o^4}{\kappa M} \sim \frac{E_{\text{sn}} c R_o}{\kappa M}$$

- This provides an excellent estimate for the peak luminosity of Type IIP SNe ($\sim 10^{43}$ erg s⁻¹) where R_o is large for red giants.

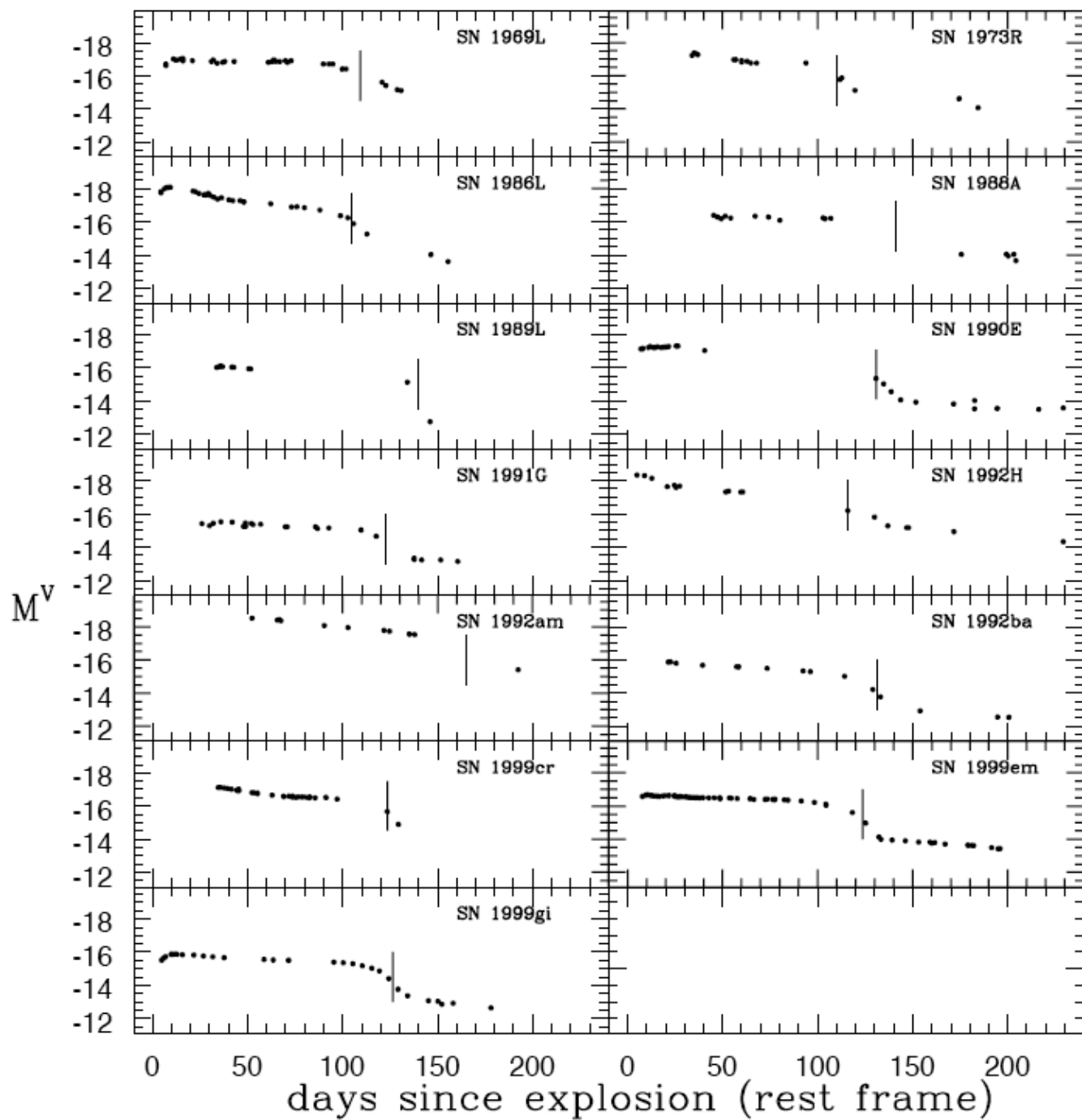

Type IIP Supernovae: Analytics vs. Numerics and Observations

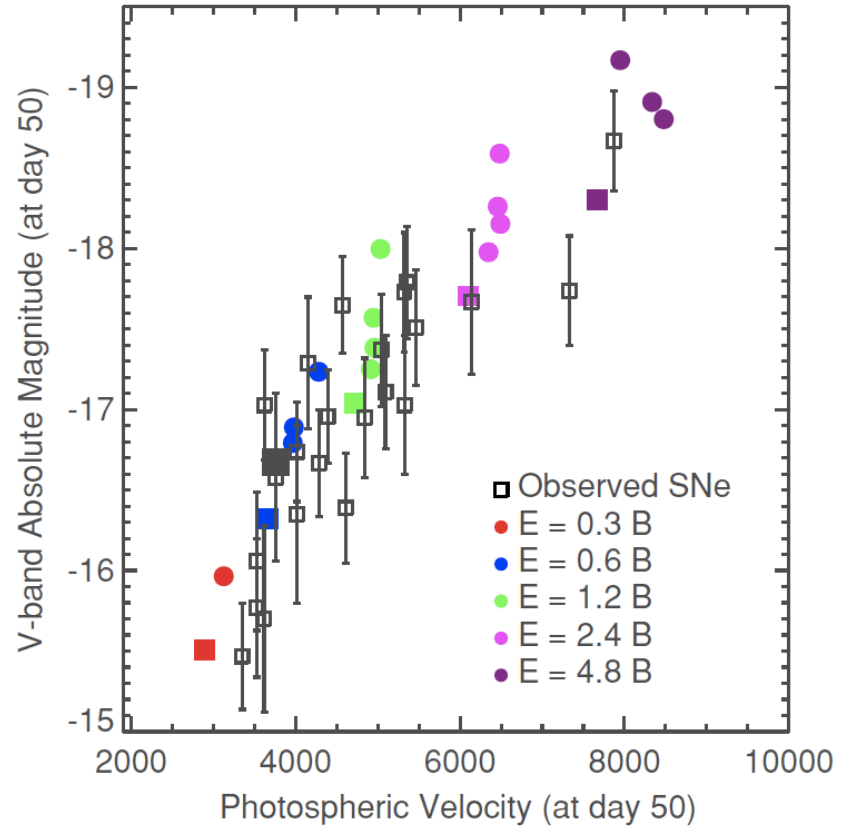
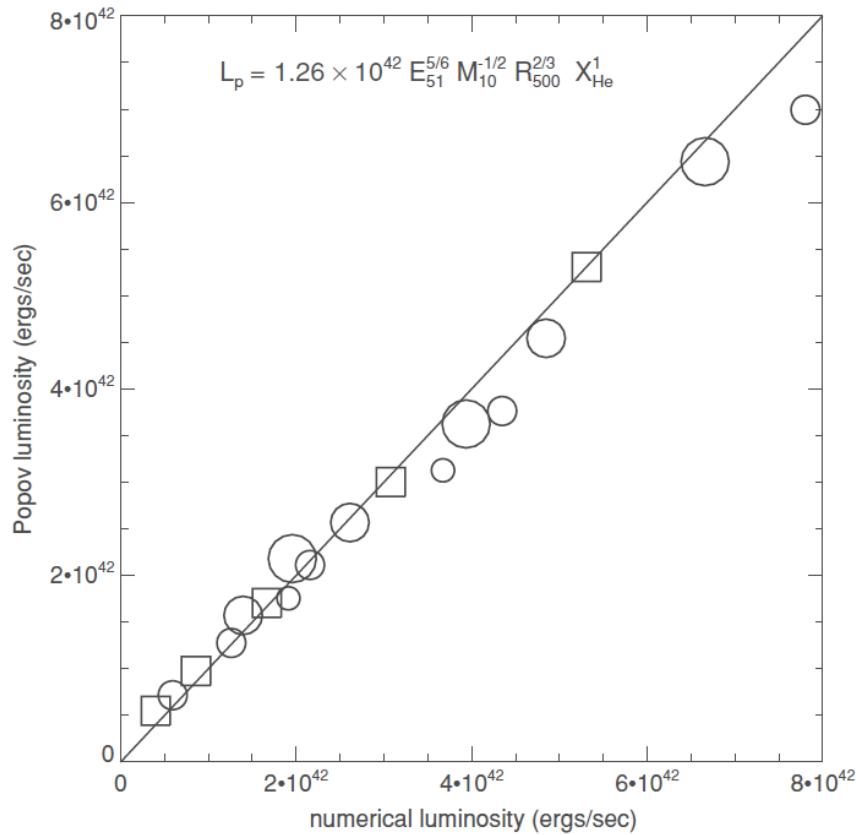

Kasen & Woosley '09

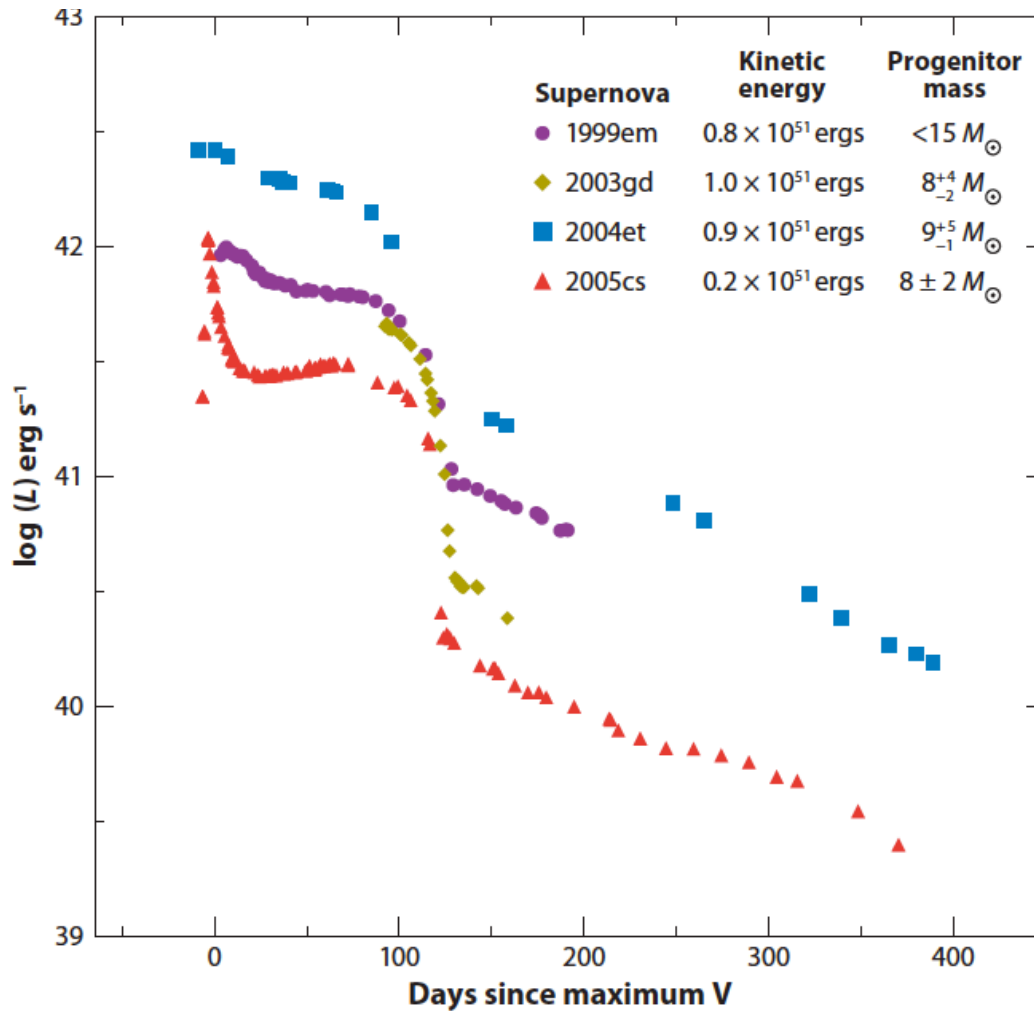
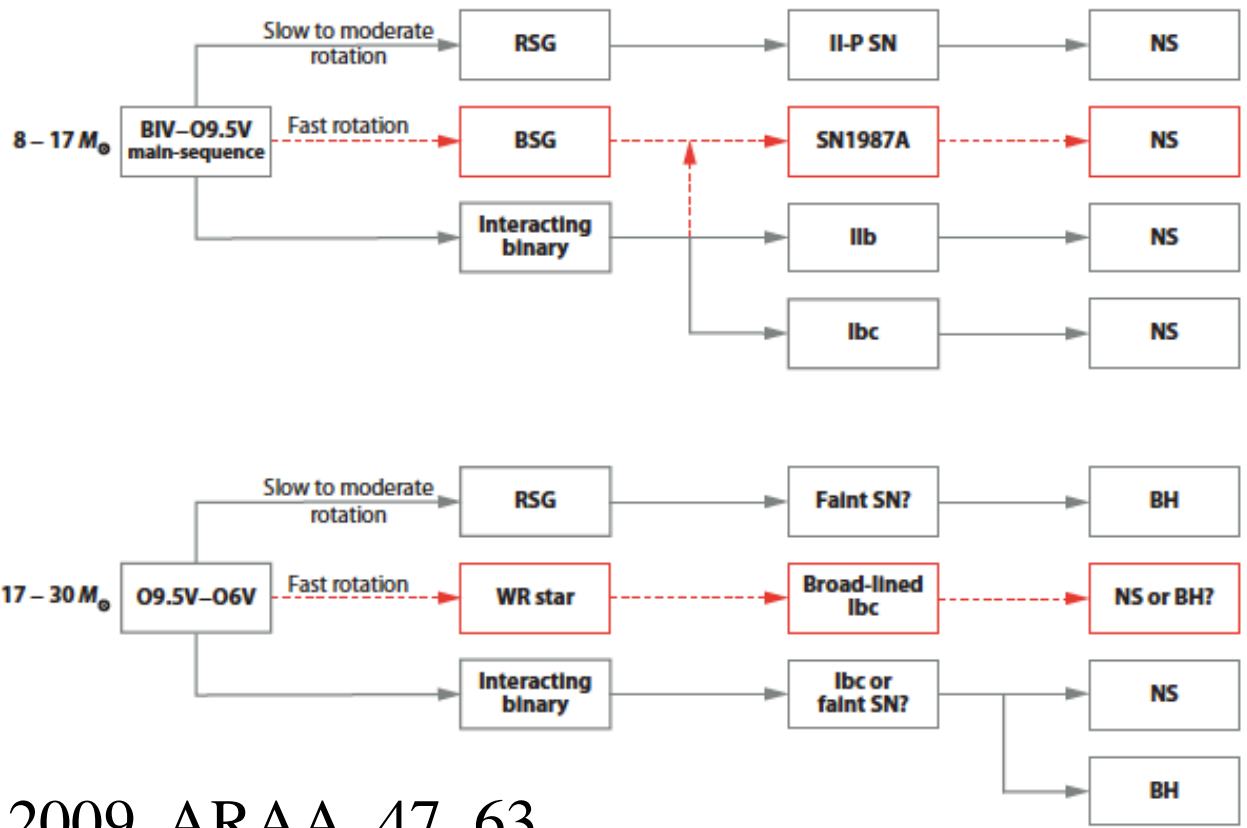
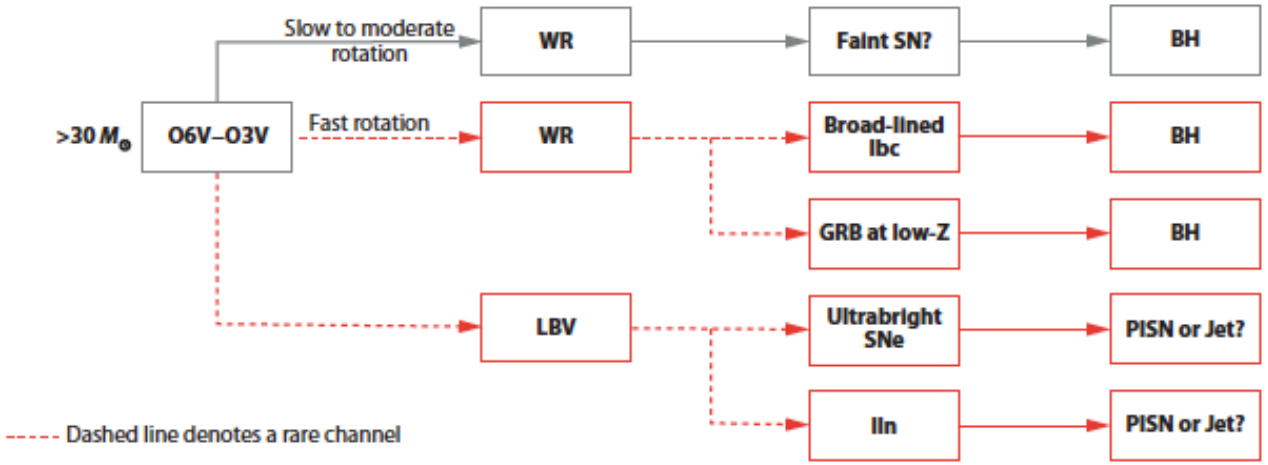

Figure 10

Bolometric lightcurves of II-P supernovae. These four are likely to have had similar progenitor stars and the progenitors of SN2003gd and SN2005cs appear to be identical. There is a large diversity in bolometric luminosity, kinetic energy, and ^{56}Ni mass from similar progenitors, hinting at intrinsic differences in the explosions. Data sources are: SN1999em, Elmhamdi et al. (2003); SN2003gd, Hendry et al. (2005); SN2005cs, Pastorello et al. (2009); and SN2004et, Misra et al. (2007).



Smartt 2009, ARAA, 47, 63



ROTSE (V=18, 200 deg²)

SN 2005ap: A MOST BRILLIANT EXPLOSION

ROBERT M. QUIMBY,¹ GREG ALDERING,² J. CRAIG WHEELER,¹ PETER HÖFLICH,³ CARL W. AKERLOF,⁴ AND ELI S. RYKOFF⁴

Received 2007 July 12; accepted 2007 August 29; published 2007 October 2

ABSTRACT

We present unfiltered photometric observations with ROTSE-III and optical spectra and the Keck telescope of the most luminous supernova yet identified, SN 2005ap. 3 days before and 6 days after maximum light show narrow emission lines (likely α and absorption lines at a redshift of $z = 0.2832$, which puts the peak unfiltered absolute. Broad P Cygni features corresponding to $H\alpha$, C III, N III, and O III are further velocity of $\sim 20,000 \text{ km s}^{-1}$. Unlike other highly luminous supernovae such as 2005ap, SN 2005ap shows a slow photometric evolution, the light curve of SN 2005ap indicates a 1–3 week relatively rapid decay. The spectra also lack the distinct emission peaks from m (likely m $\sim 2000 \text{ km s}^{-1}$) Balmer lines seen in SN 2006gy and SN 2006tf. We briefly discuss the luminosity from a strong interaction as may be expected from a pair instability event encased in a H/He envelope.

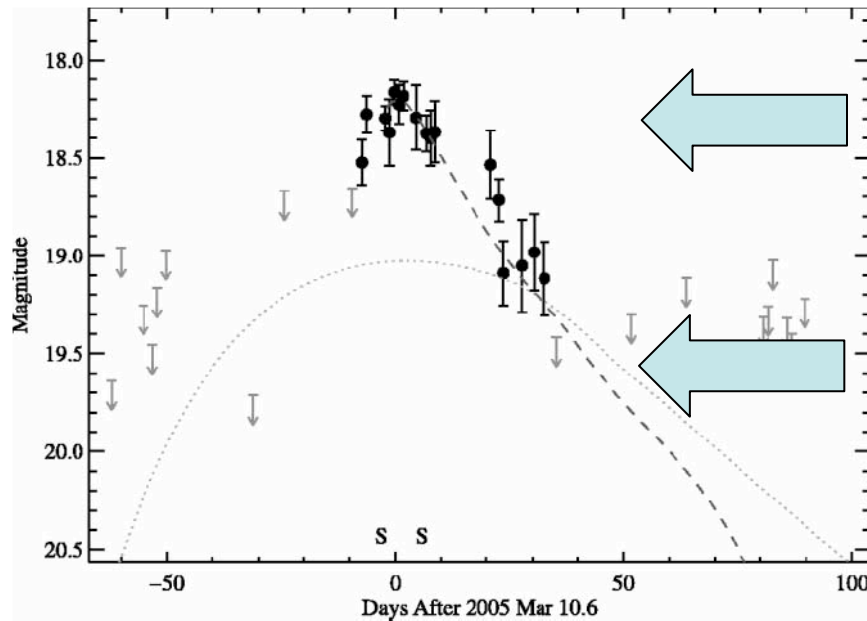

2005ap had photospheric spectra

2006gy (2006tf as well) had evidence for interaction => IIn (see Smith & McCray '07)

Who Ordered This???

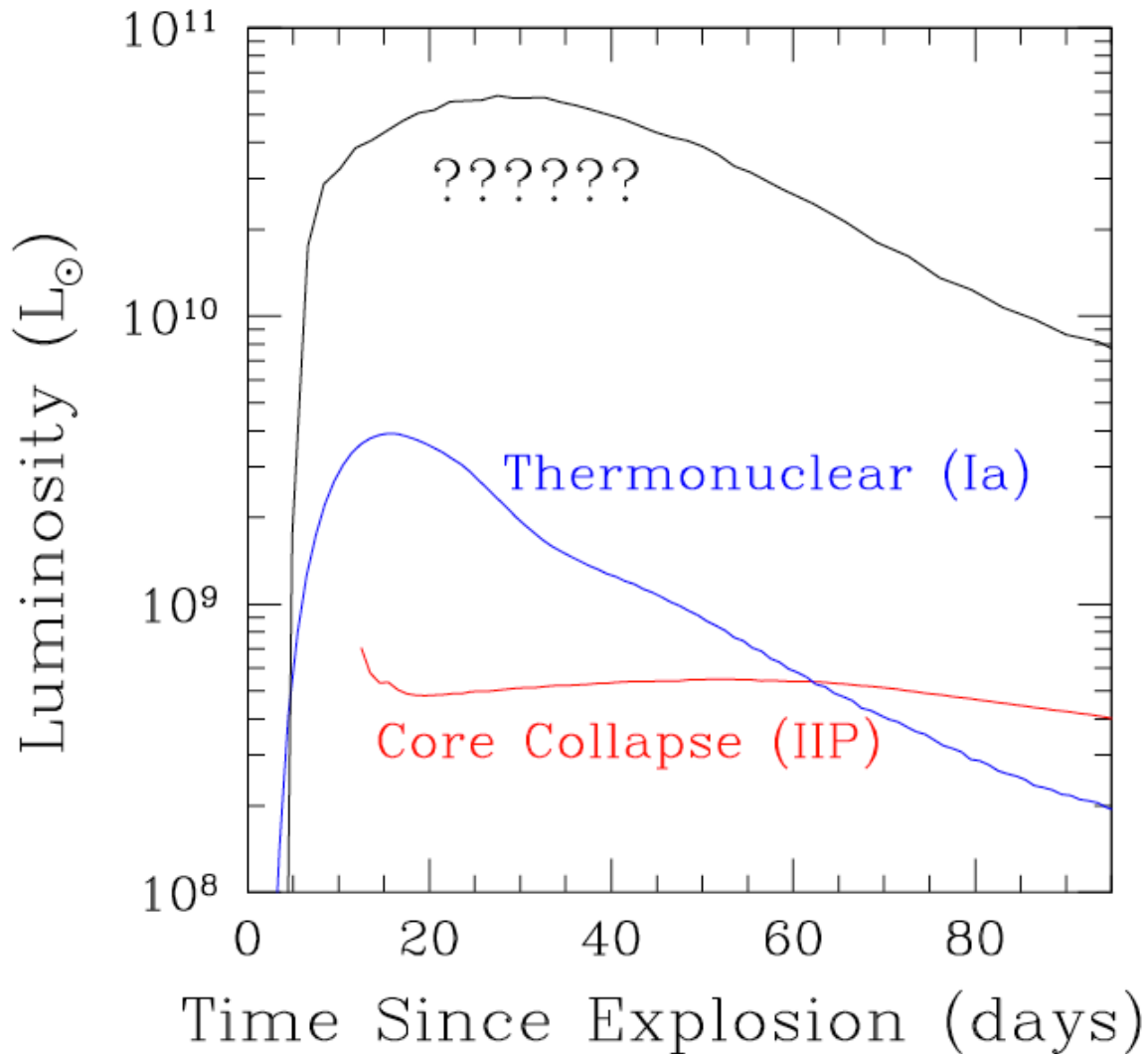

- Associated with actively star forming galaxies => massive stars..
- 100 times brighter than typical core collapse supernovae
- Likely < 1% of all core collapse events

2008es: $L_{\text{peak}} = 3 \times 10^{44} \text{ erg sec}^{-1}$

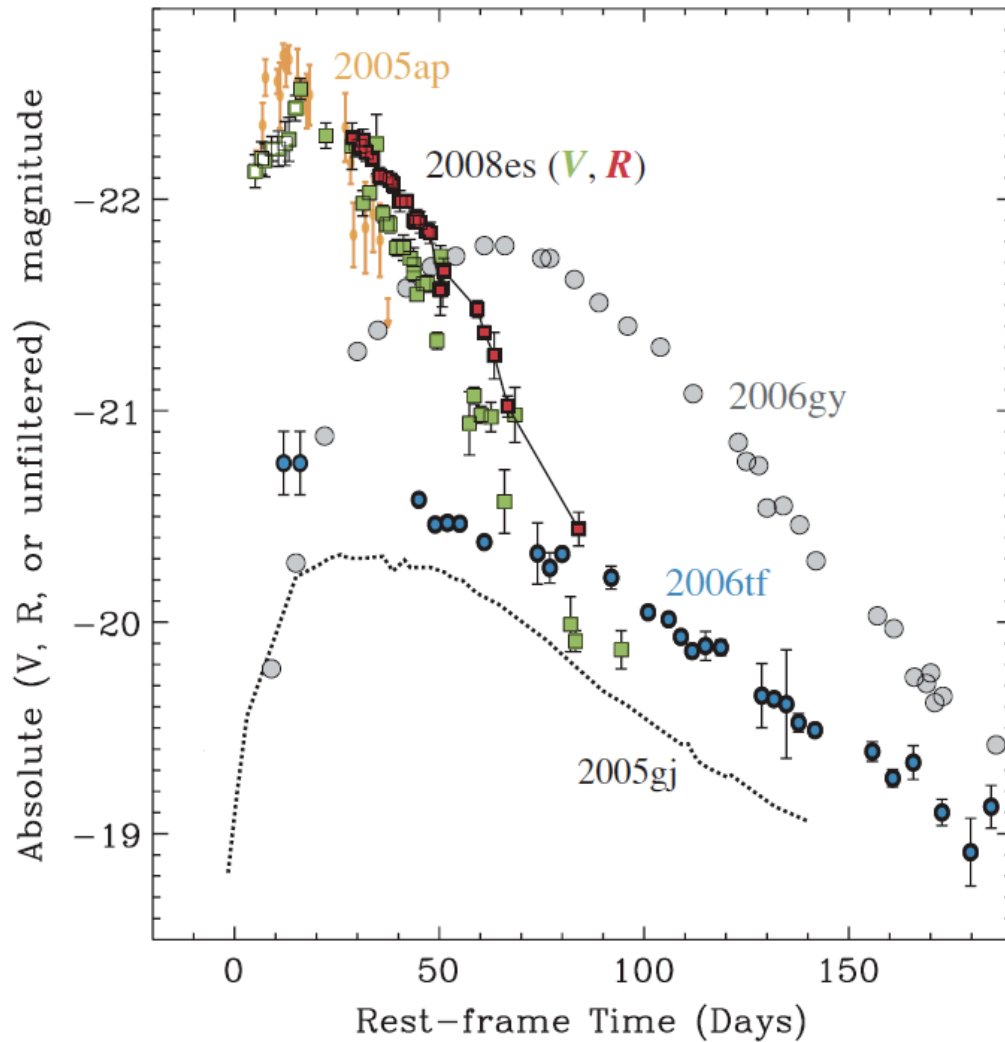

Miller et al. 2009

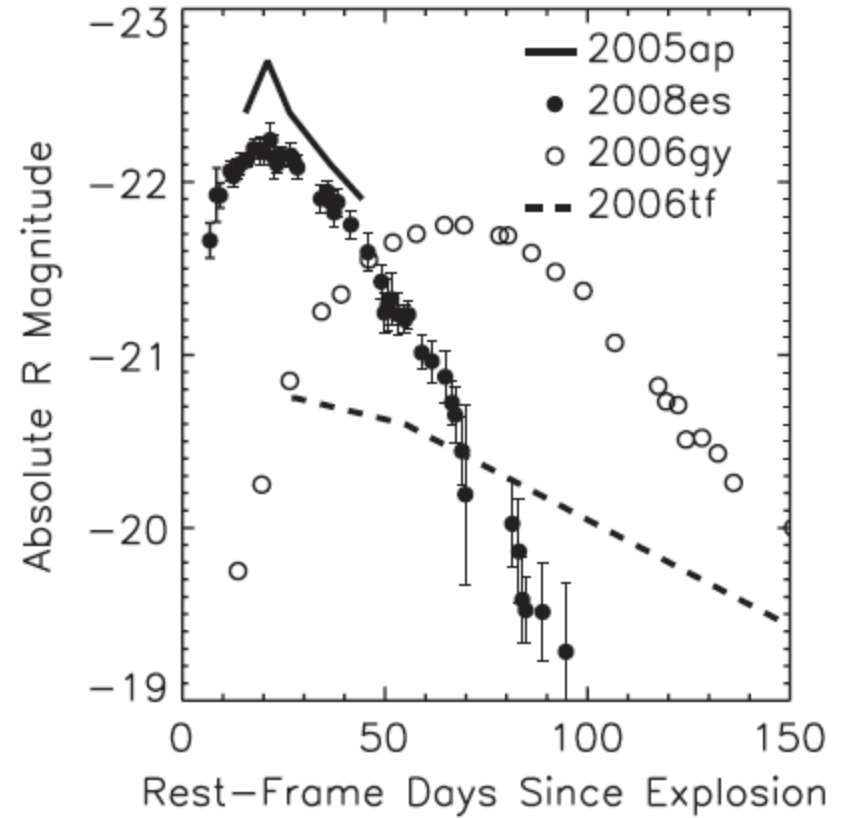

Gezari et al. 2009

Births of Magnetars!

- About $\sim 10\%$ of NSs are born with $10^{14} \text{ G} < B < 10^{15} \text{ G}$. If born spinning at $P=10\text{ms}$ P_{10} spin-down will occur in:

$$t_p = \frac{6I_{\text{ns}}c^3}{B^2 R_{\text{ns}}^6 \Omega_i^2} = 1.3 B_{14}^{-2} P_{10}^2 \text{ yr}$$

- To substantially impact lightcurve, want this to occur before diffusion kicks in, requiring

$$B > 1.8 \times 10^{14} P_{10} \kappa_{\text{es}}^{-1/4} M_5^{-3/8} E_{51}^{1/8} \text{ G}$$

- In the range of magnetars (Kasen & L.B. '09; Woosley '09) !!

Resetting the Entropy

- The deposition of spin-down energy resets the interior entropy

$$L \sim \frac{E_{\text{sn}} c R_o}{\kappa M} \rightarrow \frac{E_p c (v t_p)}{\kappa M}$$

- Where the available energy is the NS rotation

$$E_p = \frac{I_{\text{ns}} \Omega_i^2}{2} = 2 \times 10^{50} P_{10}^{-2} \text{ ergs}$$

- As long as $E_p > E_{\text{sn}} (R_o / v t_p)$, the entropy is reset, so don't need to have $E_p \sim E_{\text{sn}}$ to impact the lightcurve

$$L_{\text{peak}} \sim \frac{E_p t_p}{t_d^2} \sim 5 \times 10^{43} B_{14}^{-2} \kappa_{\text{es}}^{-1} M_5^{-3/2} E_{51}^{1/2} \text{ erg s}^{-1}$$

Hot Bubble Formation at One Month

Magnetar spin-down time = 1 day

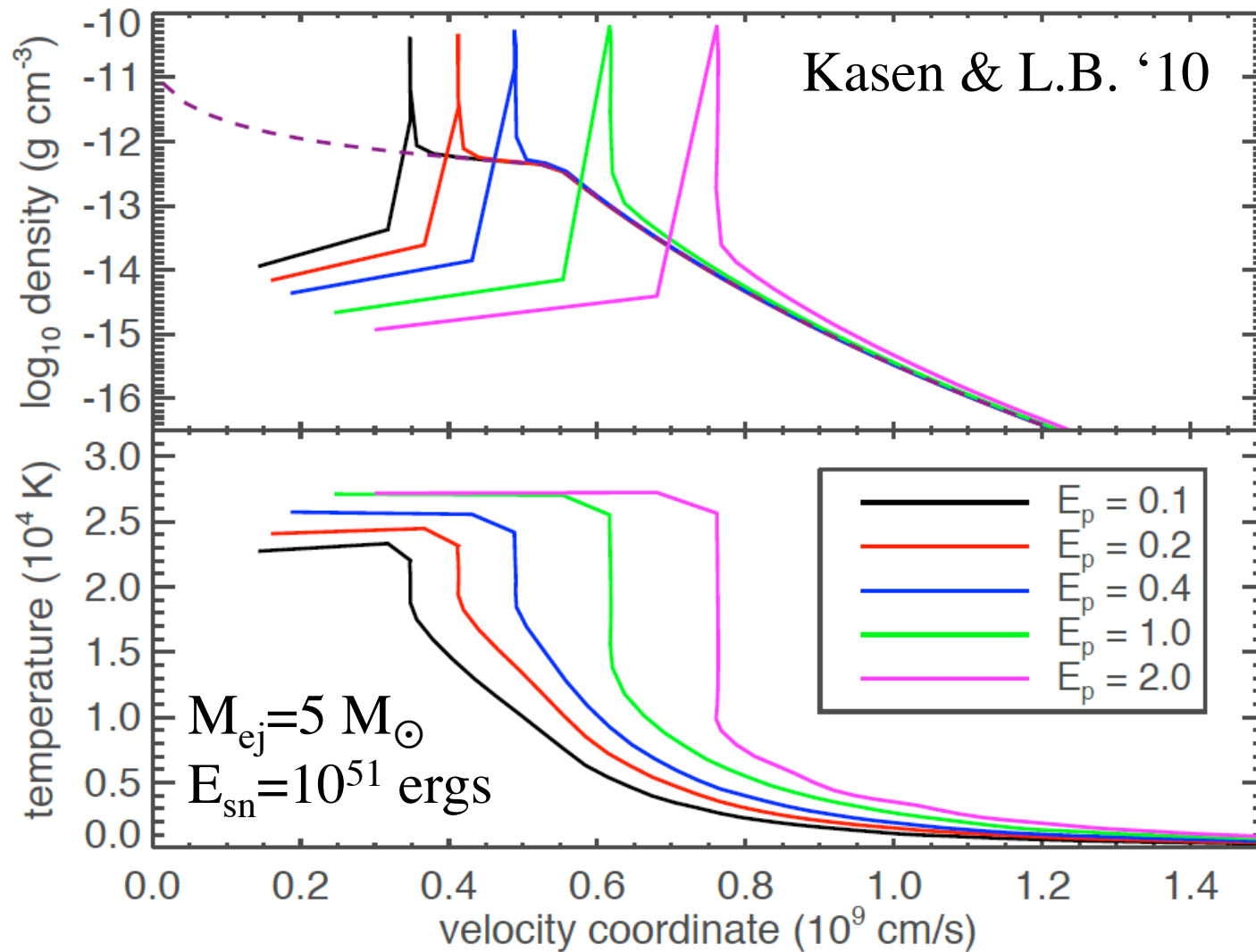

It Really Works!

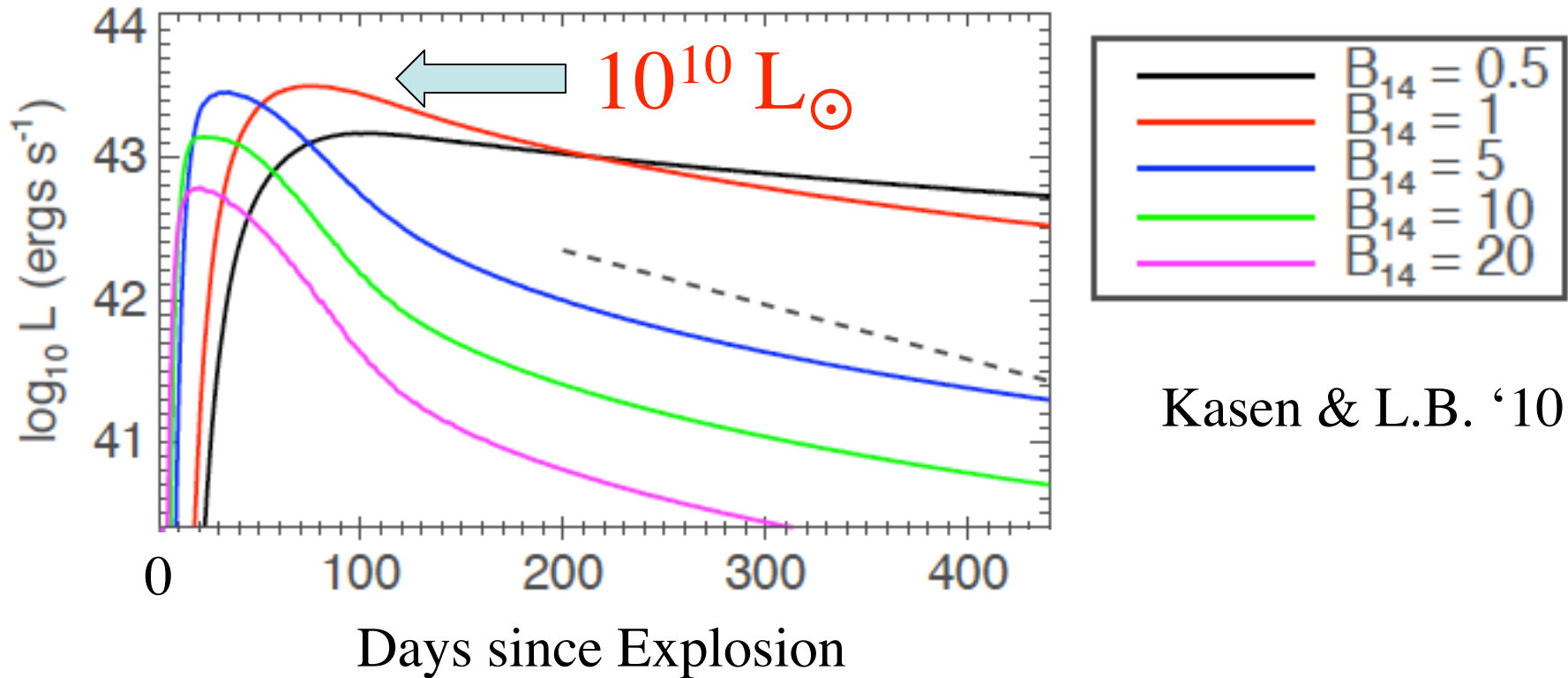

- $M_{\text{ej}} = 5 M_{\odot}$, $E_{\text{sn}} = 10^{51}$ erg, $P_i = 5$ ms
- Dashed line is $1 M_{\odot}$ of ^{56}Ni

Peak Luminosity and Duration imply Magnetar Properties

Kasen & L.B. '09

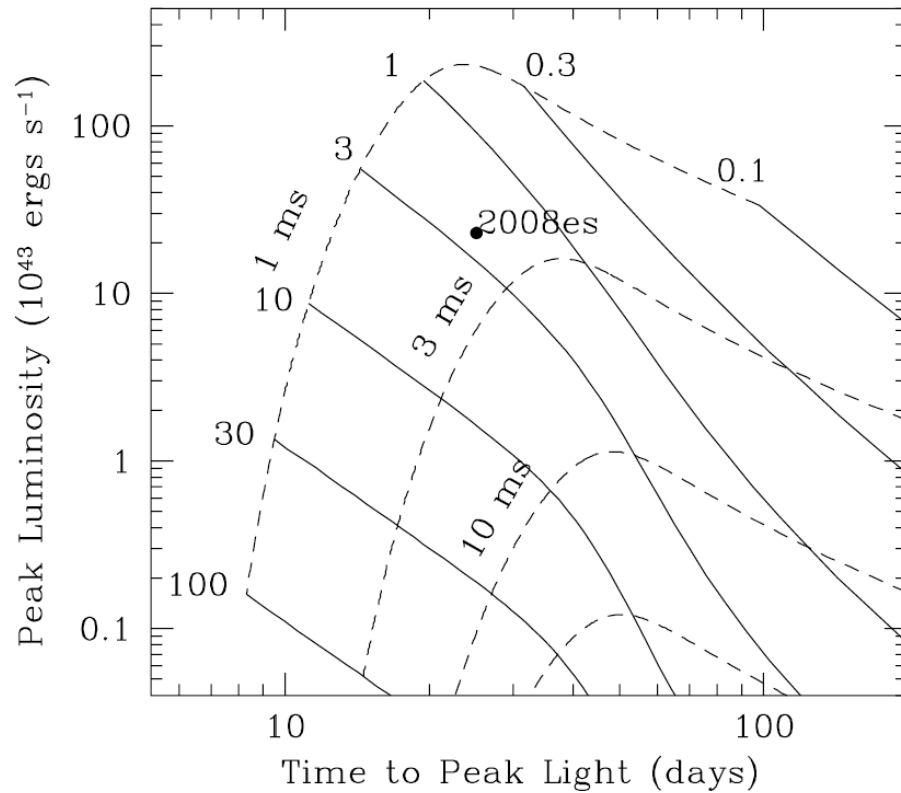

$$M_{ej} = 5 M_{\odot}$$

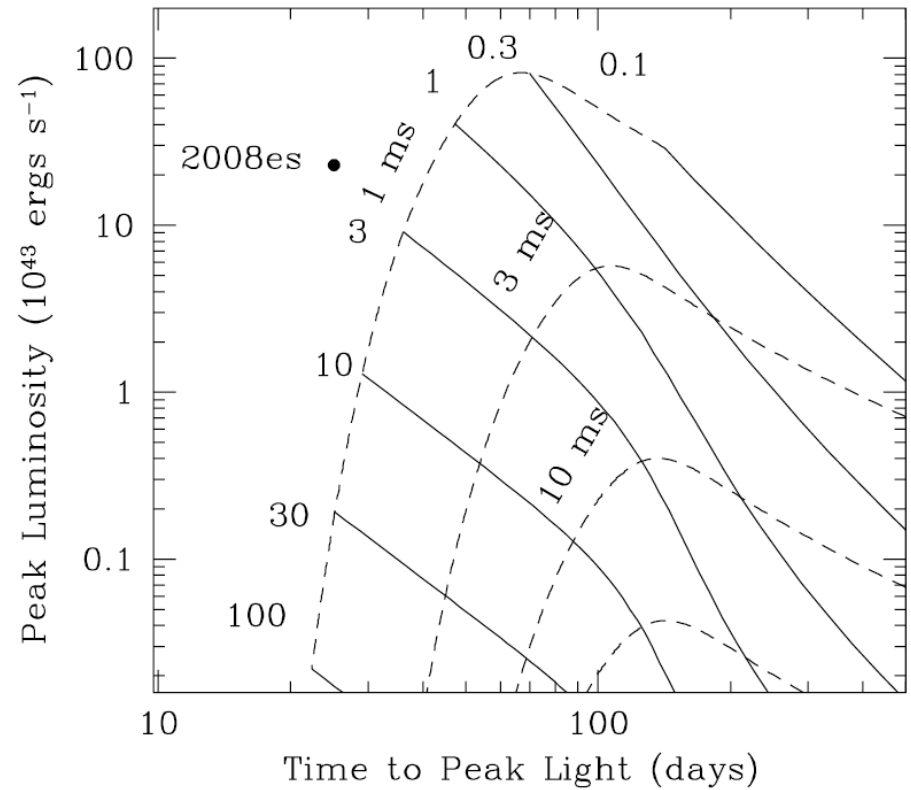

$$M_{ej} = 20 M_{\odot}$$

Radiation Hydrodynamics Examples

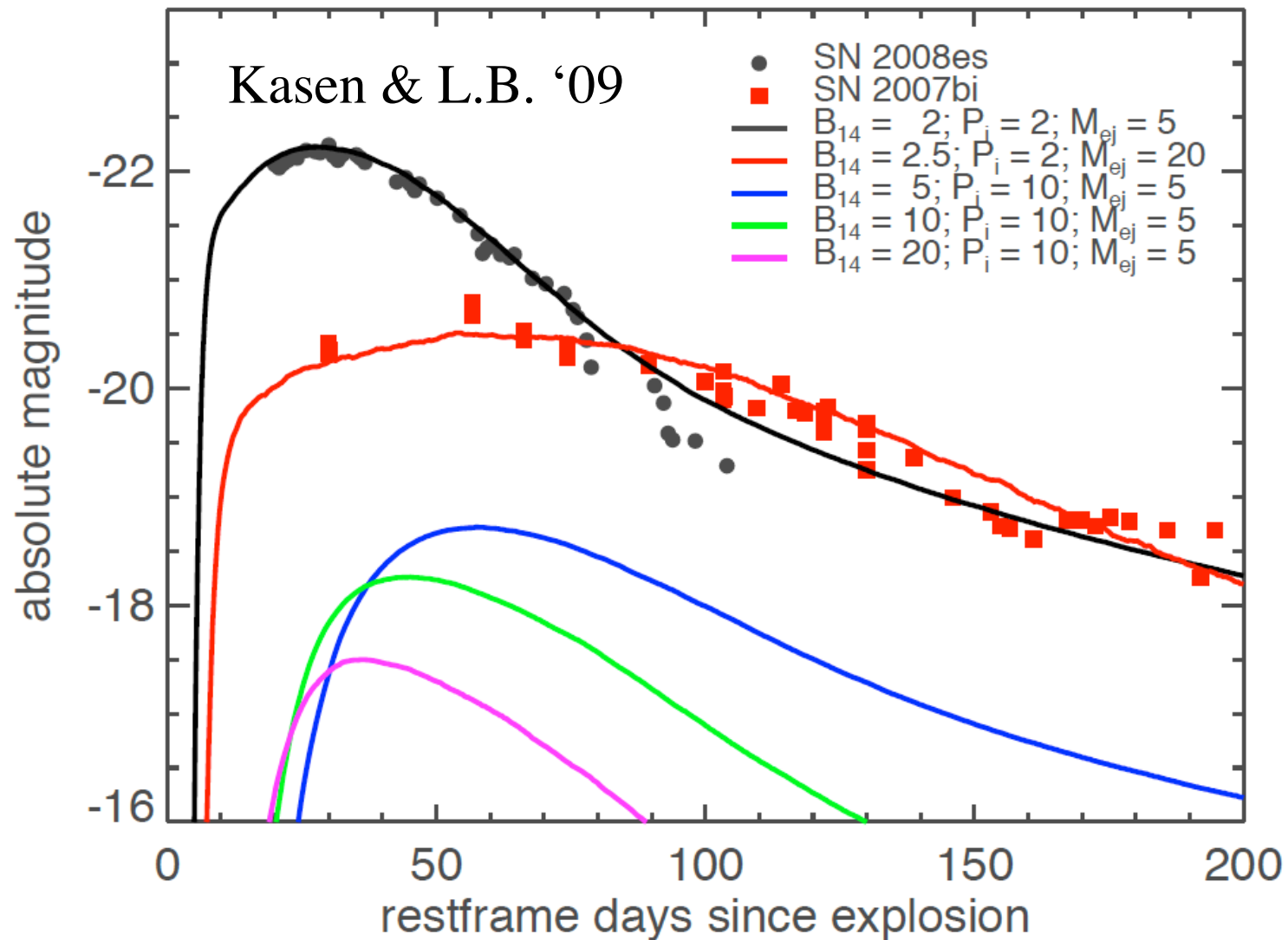

What's Next?????

